

16. – 21. Mai 2024

Mega Event

Reithof in Kreuth
Int. Bayerische ...
schaften der VWB

Freestyle Reining

4-fach AQHA-Show

NRHA-Show

VWB-Show

20.000 Euro Preisgeld

Jungpferde-Cup

mit 3.000 Euro Preisgeld

ART & Soul
Photography

Qualifikation zur

59.000 Euro VWB Series

Nähere Infos unter

www.westernreiten-online.de

Veranstalter: Vereinigung der Westernreiter in Bayern e.V.



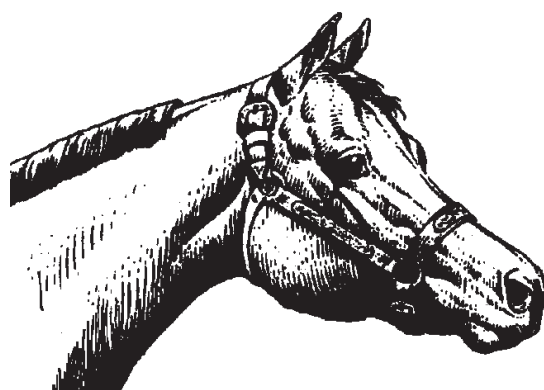

PATTERNBOOK

BAYERISCHE

MEISTERSCHAFTEN

16.-21. Mai

Bavarian Golden Series

NRHA (USA)-Show

VWB Kat I-Show

4-fach AQHA-Show

Aktuelle Show-Infos unter westernreiten-online.de

AMERICAN
QUARTER
HORSE
ASSOCIATION

NRHA



Patternübersicht

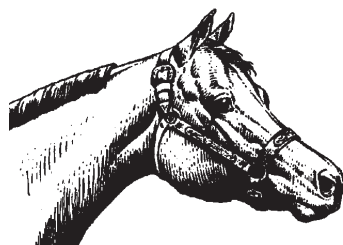

Reining

8347	VWB	Novice Jugend Reining	VWB-Pattern	5
8348	VWB	Jugend Reining	VWB-Pattern	6
9340	VWB	Einsteiger Reining	VWB-Pattern	8
7340	VWB	Amateur / Amateur Select Reining	VWB-Pattern	15
6340	VWB	Offen Reining	VWB-Pattern	11
5055	VWB	Bavarian Golden Series Reining	VWB-Pattern	1
1341	AQHA	Open Junior Reining	AQHA-Pattern	8
1342	AQHA	Open Senior Reining	AQHA-Pattern	2
1347	AQHA	Open Green Reining	AQHA-Pattern	13
2340	AQHA	Amateur Reining	AQHA-Pattern	13
3340	AQHA	Novice Amateur Reining	AQHA-Pattern	14
4340	AQHA	Youth Reining	AQHA-Pattern	5
1100	NRHA	Open Trophy	NRHA-Pattern	4
1200	NRHA	Intermediate Open	NRHA-Pattern	8
1700	NRHA	Novice Horse Open Level 1	NRHA-Pattern	15
1400	NRHA	Non Pro Trophy	NRHA-Pattern	11
1500	NRHA	Intermediate Non Pro	NRHA-Pattern	14
1600	NRHA	Limited Non Pro	NRHA-Pattern	6
3100	NRHA	Youth 14-18	NRHA-Pattern	5
3200	NRHA	Youth 0-13	NRHA-Pattern	5

Western Riding

6360	VWB	Offen Western Riding	VWB-Pattern	1
7360	VWB	Amateur Western Riding	VWB-Pattern	8
9360	VWB	Einsteiger Western Riding	VWB-Pattern	3
5057	VWB	Bavarian Golden Series Western Riding	VWB-Pattern	6
1360	AQHA	Open Western Riding	AQHA-Pattern	7
1363	AQHA	Green Western Riding	Green-Pattern	L1-7
2360	AQHA	Amateur Western Riding	AQHA-Pattern	9

Ranch Riding

6430	VWB	Offen Ranch Riding	AQHA-Pattern	12
7430	VWB	Amateur / Amateur Select Ranch Riding	AQHA-Pattern	4
9430	VWB	Einsteiger Ranch Riding	AQHA-Pattern	10
8430	VWB	Jugend Ranch Riding	AQHA-Pattern	3
1430	AQHA	Open Ranch Riding	AQHA-Pattern	7
2430	AQHA	Amateur Ranch Riding	AQHA-Pattern	1
5054	VWB	Bavarian Golden Series Ranch Riding	Seite	20

Patternübersicht



Jungpferde

6840	VWB	Jungpferde-Reining	VWB-Pattern	1
6880	VWB	Jungpferde-Trail	VWB-Pattern	1
6890	VWB	Jungpferde-Basis	VWB-Pattern	1

Western Combination

6600	VWB	Western Combination Open	VWB-Pattern	1
------	-----	--------------------------	-------------	---

Trail

1381	AQHA	Open Junior Trail	Seite	6
1382	AQHA	Open Senior Trail	Seite	11
1383	AQHA	Green Trail	Seite	7
2380	AQHA	Amateur Trail	Seite	6
3380	AQHA	Novice Amateur Trail	Seite	7
4380	AQHA	Youth Trail	Seite	6
6380	VWB	Offen Trail	Seite	8
6390	VWB	Offen Ranch Trail	Seite	11
6830	VWB	Jungpferde-Cup In-Hand Trail	Seite	9
7388	VWB	Amateur Select Trail	Seite	8
7380	VWB	Amateur Trail	Seite	8
7390	VWB	Amateur Ranch Trail	Seite	9
9380	VWB	Einsteiger Trail	Seite	7
8387	VWB	Novice Jugend	Seite	12
8388	VWB	Jugend	Seite	12
5050	VWB	Bavarian Golden Series Trail	Seite	10
5056	VWB	Bavarian Limited Series Trail	Seite	10

Showmanship

	VWB	alle Showmanship VWB	Seite	13-15
	AQHA	alle Showmanship AQHA	Seite	16
6810	VWB	Jungpferde-Cup	Seite	14
5052	VWB	Bavarian Golden Series Showmanship	Seite	18

Horsemanship

	VWB	alle Horsemanship VWB	Seite	17 / 18
	AQHA	alle Horsemanship AQHA	Seite	19
5053	VWB	Bavarian Golden Series Horsemanship	Seite	20

Hunt Seat Equitation

	AQHA	alle Hunt Seat Equitation AQHA	Seite	22
--	------	--------------------------------	-------	----

Thursday 16.5.2024

#1381 AQHA JR HORSE
#4380 AQHA JUGEND

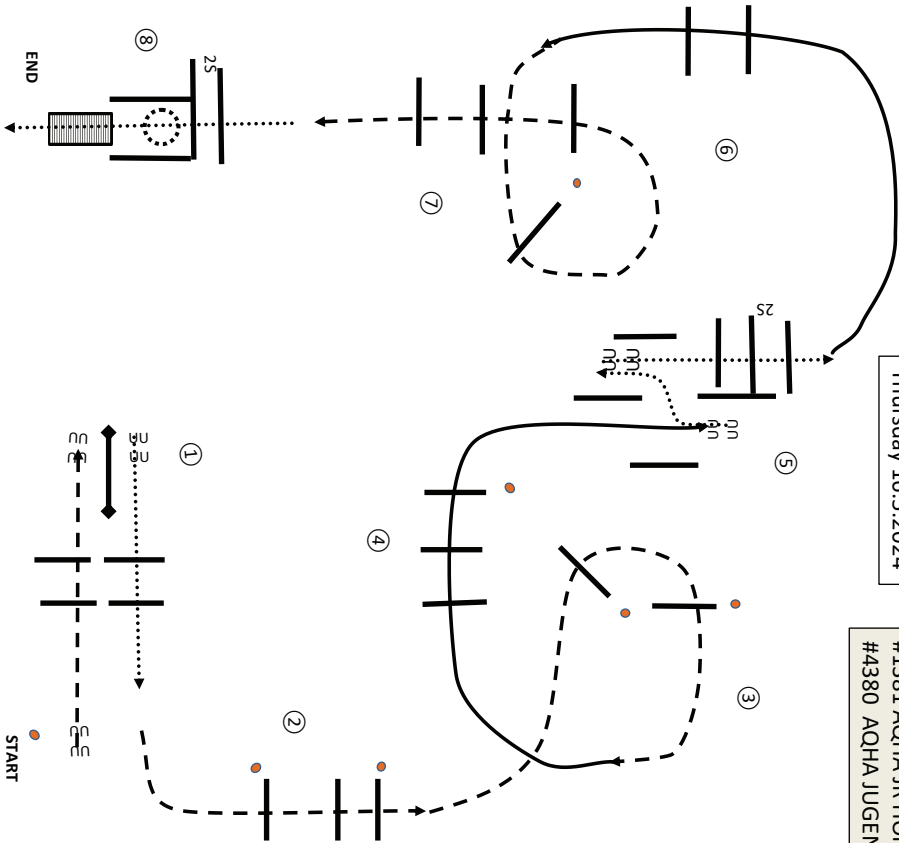

- 1 JOG OVER TO GATE STOP-RH GATE OPEN RIDE THRU CLOSE WALK OVERS
- 2 JOG OVERS
- 3 SERPENTINE JOG OVERS
- 4 RL LOPE OVERS INTO CHUTE
- 5 STOP-BACK- WALK OVERS
- 6 LL LOPE OVERS
- 7 JOG OVERS
- 8 STOP OR BREAK TO A WALK-WALK OVERS 360 EITHER WAY- BRIDGE END OF PATTERN

ANDBENNSDESIGN COPYRIGHT 2024
ALL RIGHTS RESERVED

Thursday 16.5.2024

#2380 AQHA AMATEUR

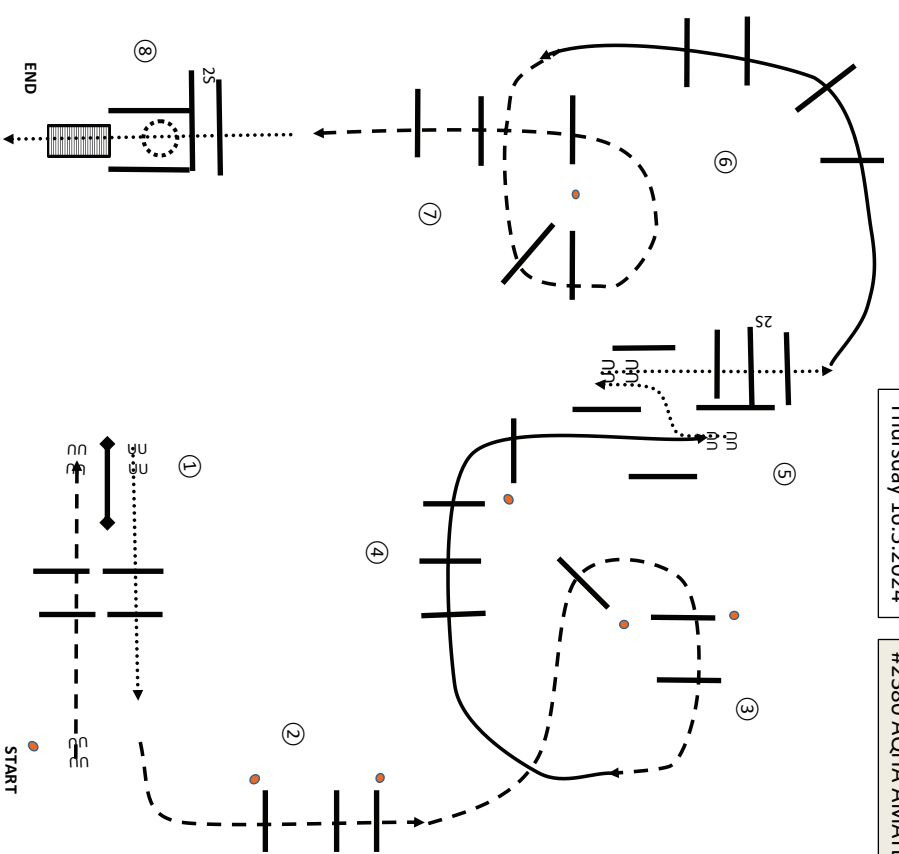

- 1 JOG OVER TO GATE STOP-RH GATE OPEN RIDE THRU CLOSE WALK OVERS
- 2 JOG OVERS
- 3 SERPENTINE JOG OVERS
- 4 RL LOPE OVERS INTO CHUTE
- 5 STOP-BACK- WALK OVERS
- 6 LL LOPE OVERS
- 7 JOG OVERS
- 8 STOP OR BREAK TO A WALK-WALK OVERS 360 EITHER WAY- BRIDGE END OF PATTERN

ANDBENNSDESIGN COPYRIGHT 2024
ALL RIGHTS RESERVED

Thursday 16.5.2024

#9380 VWVB EINSTEIGER

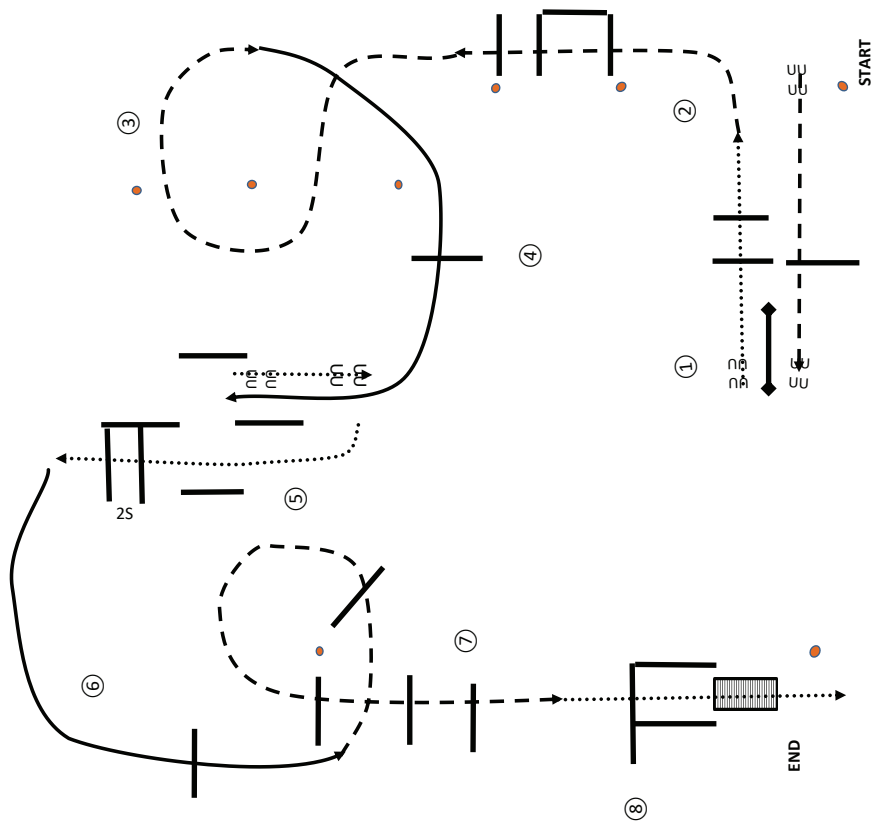

- 1 JOG OVER TO GATE STOP-RH GATE OPEN RIDE THRU CLOSE
WALK OVERS
- 2 JOG OVERS
- 3 SERPENTINE JOG OVERS
- 4 RL LOPE OVER INTO CHUTE
- 5 STOP-BACK- WALK OVERS
- 6 LL LOPE OVER
- 7 JOG OVERS
- 8 STOP OR BREAK TO A WALK-WALK OVER- BRIDGE
END OF PATTERN

ANNDENNISDESIGN COPYRIGHT 2024
ALL RIGHTS RESERVED

FRIDAY 17.5.2024

#3380 AQHA NOVICE AMATEUR
#1383 AQHA GREEN TRAIL

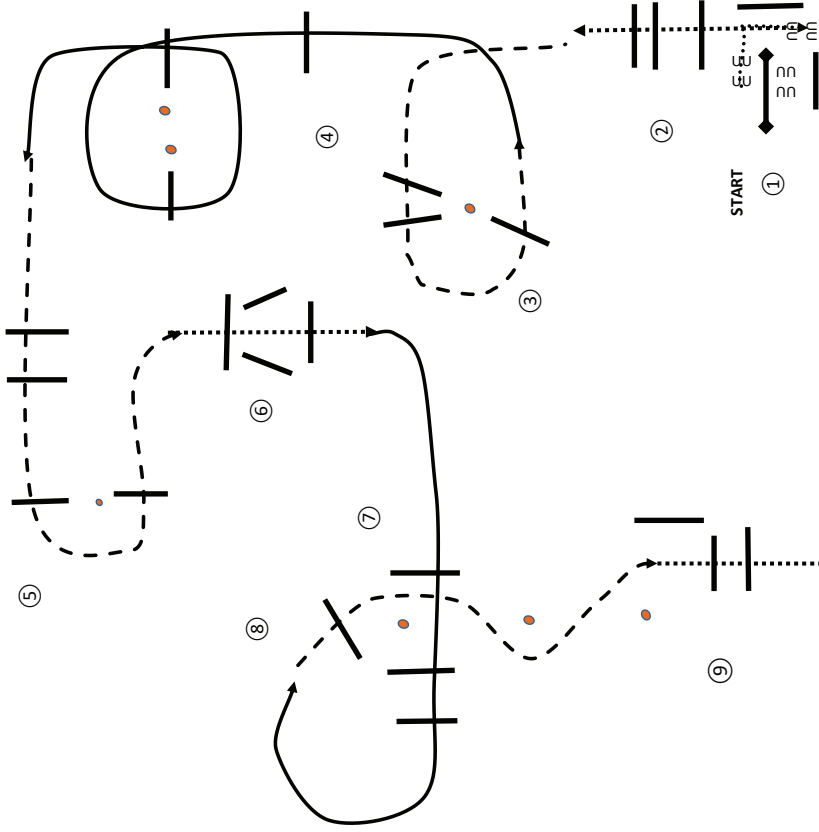

- 1 LH GATE-GATE-OPEN RIDE THRU CLOSE
BACK L
- 2 WALK OVERS
- 3 JOG OVERS
- 4 LL LOPE OVERS-BREAK TO JOG
- 5 JOG OVERS
- 6 STOP OR BREAK TO A WALK-WALK OVERS
- 7 RL LOPE OVERS
- 8 SERPENTINE JOG OVERS
- 9 STOP OR BREAK TO WALK-WALK OVERS-BRIDGE
END OF PATTERN

ANNDENNISDESIGN COPYRIGHT 2024
ALL RIGHTS RESERVED

FRIDAY 17.5. 2024

#7388 VWB AMATEUR SELECT
#7380 VWB AMATEUR

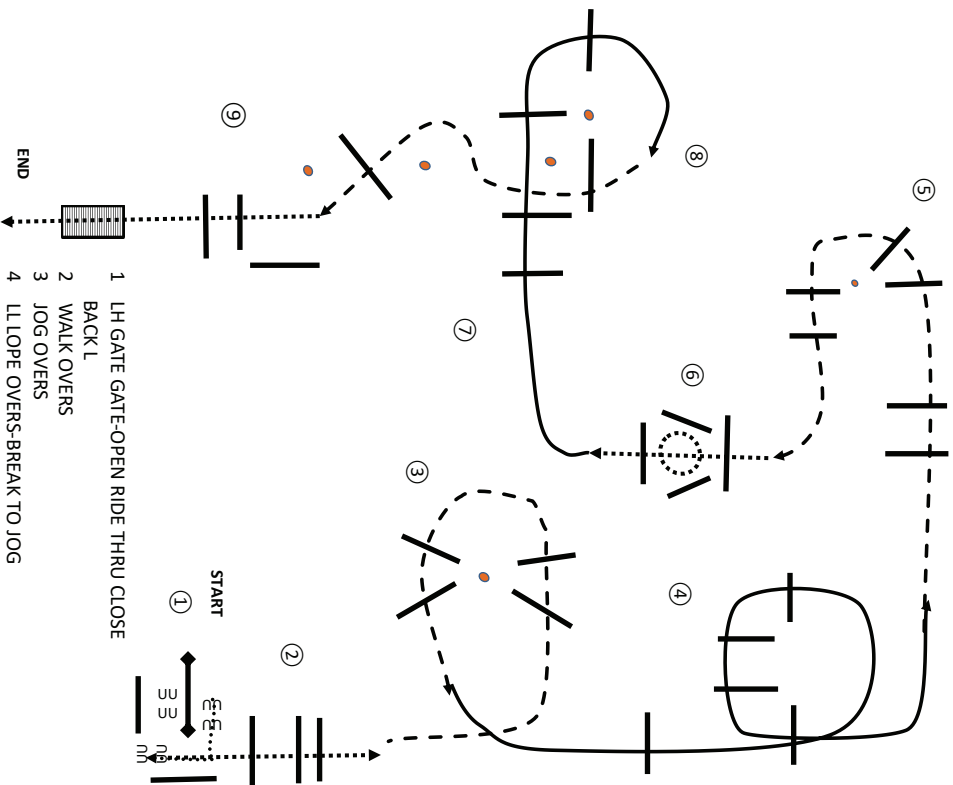

ANNDENISDESIGN COPYRIGHT 2024
ALL RIGHTS RESERVED

SATURDAY 18.5. 2024

#6380 VWB TRAIL ALL AGES

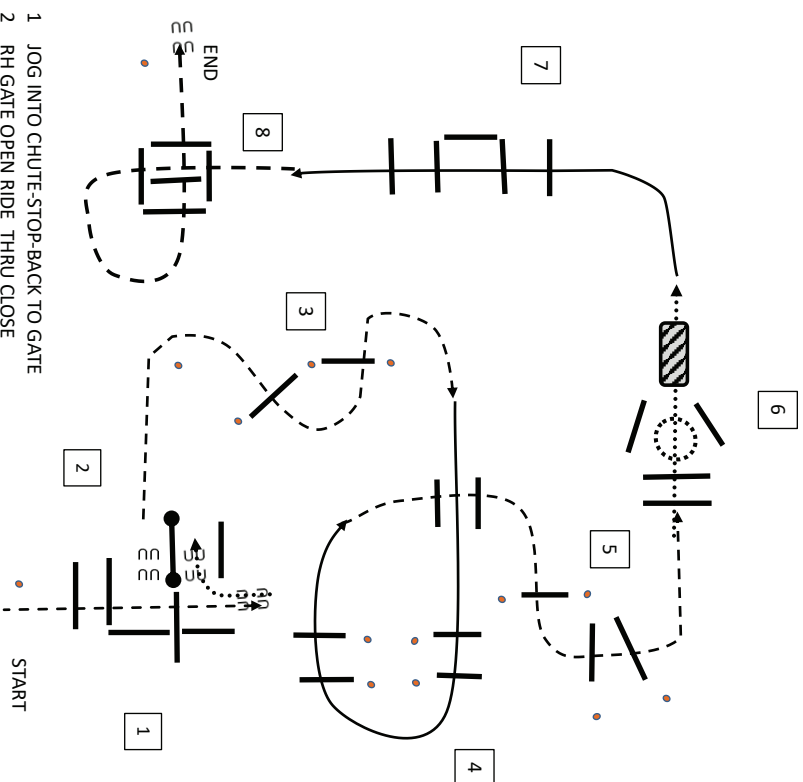

- 1 JOG INTO CHUTE-STOP-BACK TO GATE
 - 2 RH GATE OPEN RIDE THRU CLOSE
 - 3 SERPENTINE JOG OVERS
 - 4 RL LOPE OVERS
 - 5 JOG OVERS
 - 6 STOP OR BREAK TO A WALK-WALK OVERS 360
 - 7 RIGHT OR LEFT-WALK OVER BRIDGE
 - 8 JOG OVERS-STOP
- END OF PATTERN

ANNDENISDESIGN COPYRIGHT 2024
ALL RIGHTS RESERVED

SATURDAY 18.5.2024

#6830 VWB JUNGPFERDE IN HAND TRAIL

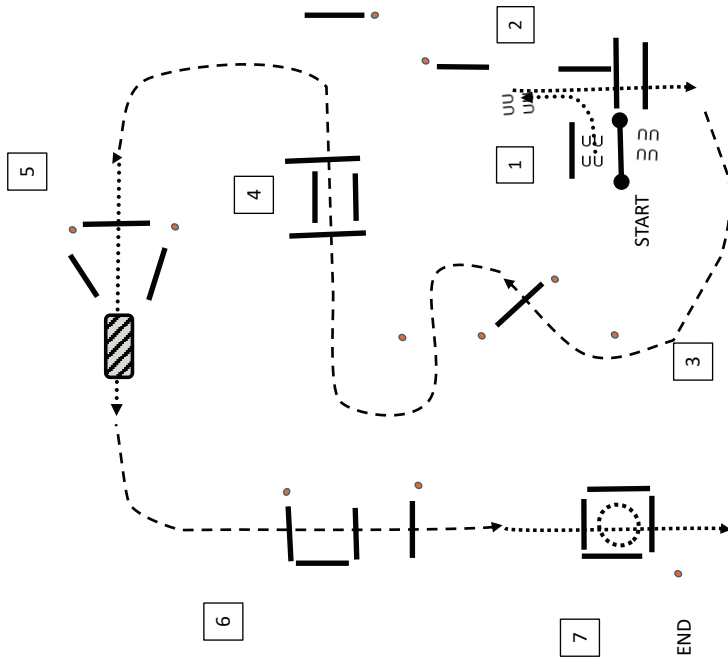

- 1 LH GATE OPEN RIDE THRU CLOSE
- 2 BACK INTO CHUTE-WALK OVERS
- 3 JOG SERPENTINE OVER POLES
- 4 JOG OVER POLES THRU CHUTE
- 5 STOP OR BREAK TO A WALK-WALK OVER- BRIDGE
- 6 JOG OVERS
- 7 STOP OR BREAK TO A WALK-WALK IN BOX 360 RIGHT-WALK OVER

END OF PATTERN

ANNDENNISDESIGN COPYRIGHT 2024
ALL RIGHTS RESERVED

SATURDAY 18.5.2024

7390 VWB AMATEUR RANCH TRAIL

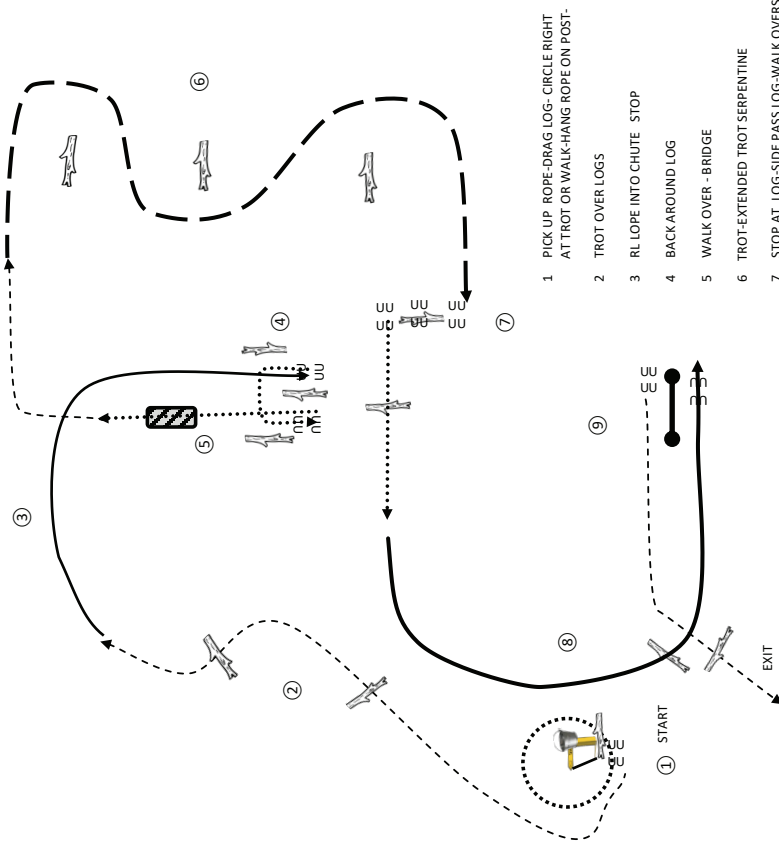

- 1 PICK UP ROPE-DRAG LOG- CIRCLE RIGHT
ATTROT OR WALK-HANG ROPE ON POST-
- 2 TROT OVER LOGS
- 3 RL LOPE INTO CHUTE STOP
- 4 BACK-AROUND LOG
- 5 WALK OVER - BRIDGE
- 6 TROT-EXTENDED TROT SERPENTINE
- 7 STOP AT LOG-SIDE PASS LOG-WALK OVERS
- 8 LL LOPE OVER LOG-TO GATE
- 9 WORK GATE-TROT OUT OVER LOG TO EXIT
END OF PATTERN

SUNDAY 19.5.2024

5056 VWB LIMITED SERIES TRAIL

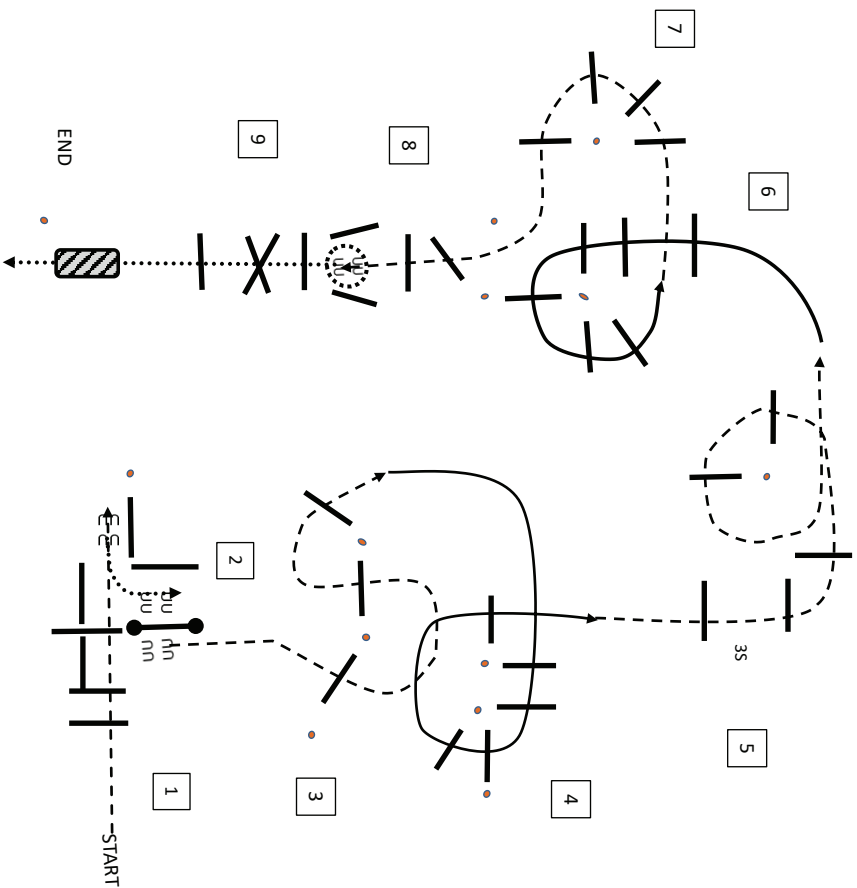

- 1 JOG INTO CHUTE-STOP
- 2 BACK TO GATE-LH GATE OPEN RIDE THRU CLOSE
- 3 SERPENTINE JOG OVERS
- 4 RL LOPE OVERS
- 5 JOG OVERS
- 6 LL LOPE OVERS
- 7 JOG OVERS
- 8 JOG OVERS-STOP 360 RIGHT OR LEFT
- 9 WALK OVERS BRIDGE

ANNDENNISDESIGN COPYRIGHT 2024
ALL RIGHTS RESERVED

SUNDAY 19.5.2024

5050 VWB SERIES TRAIL

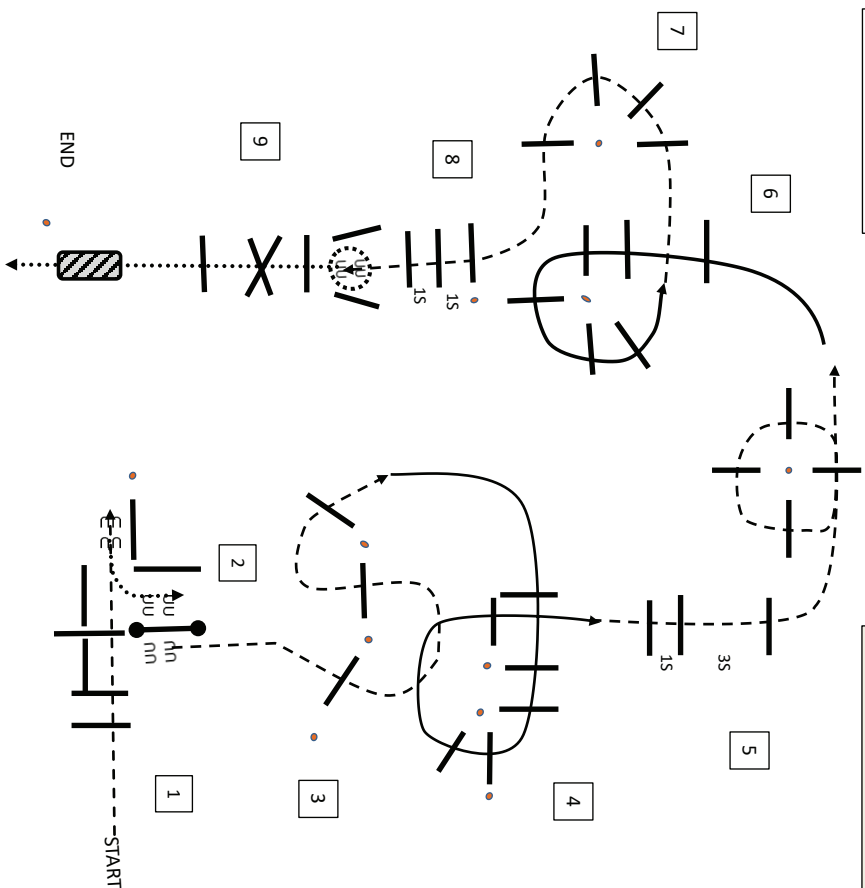

- 1 JOG INTO CHUTE-STOP
- 2 BACK TO GATE-LH GATE OPEN RIDE THRU CLOSE
- 3 SERPENTINE JOG OVERS
- 4 RL LOPE OVERS
- 5 JOG OVERS
- 6 LL LOPE OVERS
- 7 JOG OVERS
- 8 JOG OVERS-STOP 360 RIGHT OR LEFT
- 9 WALK OVERS BRIDGE

ANNDENNISDESIGN COPYRIGHT 2024
ALL RIGHTS RESERVED

SUNDAY 19.5.2024

6390 VWB OPEN RANCH TRAIL

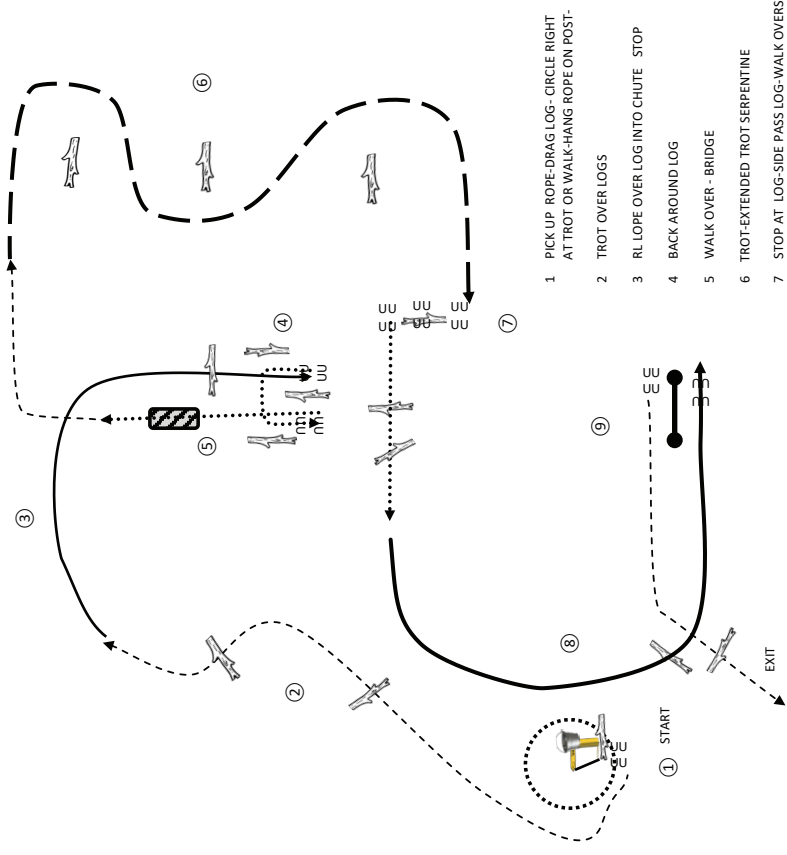

- 1 PICK UP ROPE-DRAG LOG- CIRCLE RIGHT
AT TROT OR WALK-HANG ROPE ON POST-
- 2 TROT OVER LOGS
- 3 RL LOPE OVER LOG INTO CHUTE STOP
- 4 BACK AROUND LOG
- 5 WALK OVER - BRIDGE
- 6 TROT-EXTENDED TROT SERPENTINE
- 7 STOP AT LOG-SIDE PASS LOG-WALK OVERS
- 8 LL LOPE OVER LOG-TO GATE
- 9 WORK GATE-TROT OUT OVER LOG TO EXIT
END OF PATTERN

ANNBENNISDESIGN COPYRIGHT 2024
ALL RIGHTS RESERVED

MONDAY 20.5 2024

#1382 SENIOR TRAIL

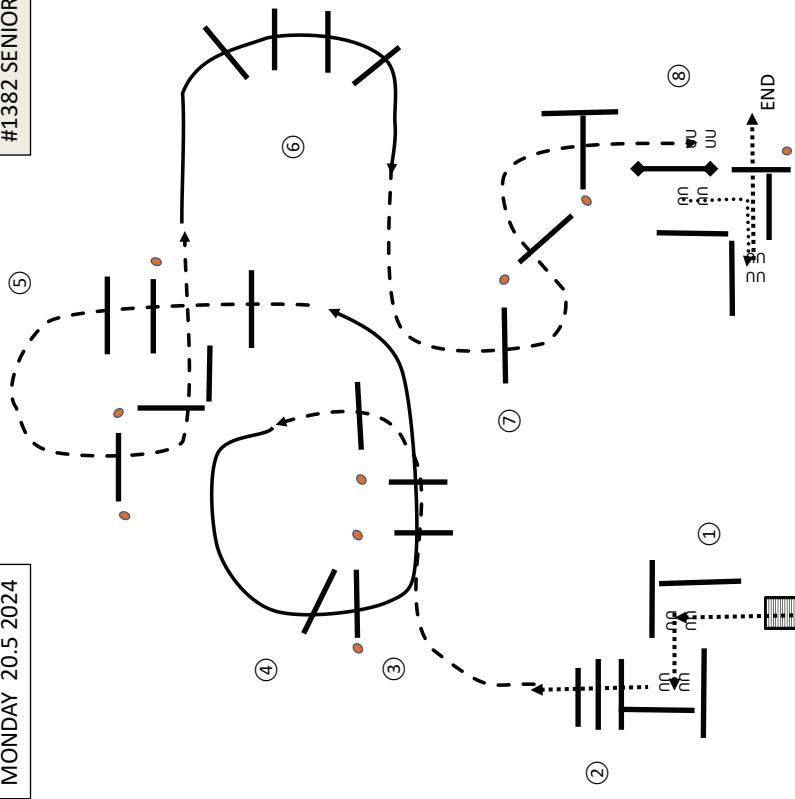

- 1 BRIDGE-SIDE PASS
- 2 WALK OVERS
- 3 JOG OVERS
- 4 LL LOPE OVERS
- 5 JOG OVERS
- 6 RL LOPE OVERS
- 7 SERPENTINE JOG OVERS TO GATE
- 8 STOP-RH GATE OPEN RIDE THRU CLOSE-BACK L
INTO CHUTE-WALK OVER
END OF PATTERN

ANNBENNISDESIGN COPYRIGHT 2024
ALL RIGHTS RESERVED

MONDAY 20.5.2024

#8387 VWB NOV JUGEND TRAIL

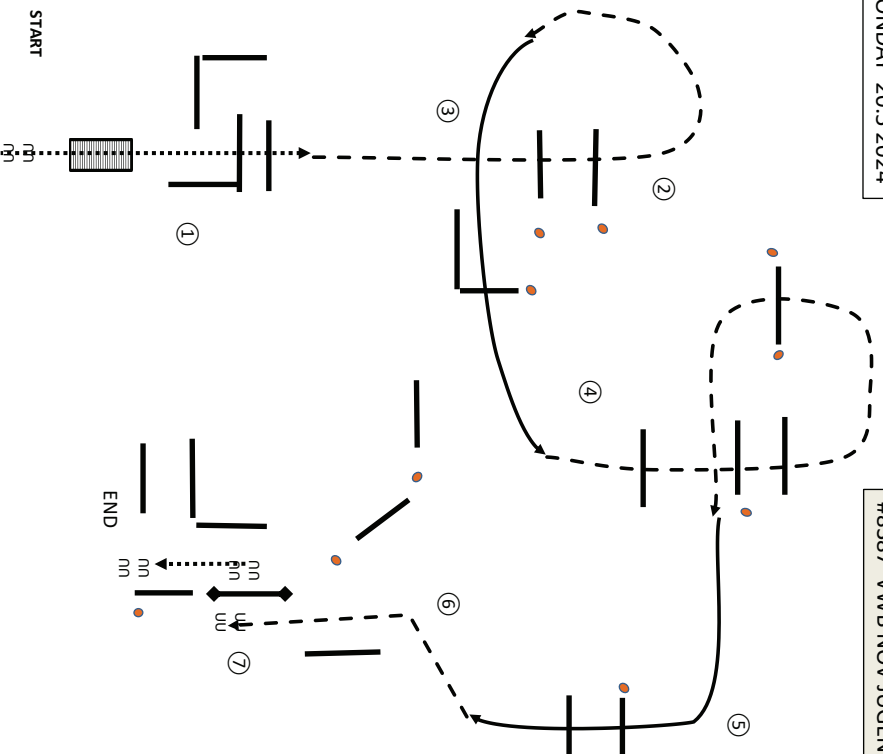

- 1 BRIDGE-WALK OVERS
- 2 JOG OVERS
- 3 LL LOPE OVER
- 4 JOG OVERS
- 5 RL LOPE OVERS
- 6 BREAK TO JOG-JOG TO GATE
- 7 STOP-RH GATE OPEN RIDE THRU CLOSE-BACK OUT CHUTE- END OF PATTERN

ANDBENNISDESIGN COPYRIGHT 2024
ALL RIGHTS RESERVED

Pattern

MONDAY 20.5.2024

#8388 VWB JUGEND TRAIL

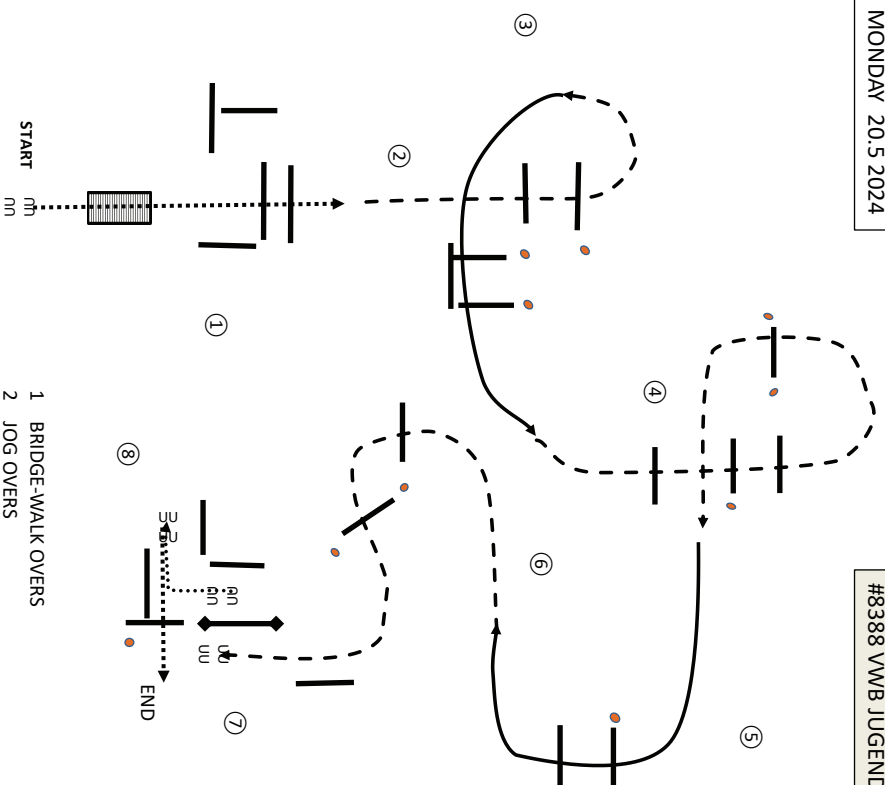

- 1 BRIDGE-WALK OVERS
- 2 JOG OVERS
- 3 LL LOPE OVERS
- 4 JOG OVERS
- 5 RL LOPE OVERS
- 6 SERPENTINE JOG OVERS TO GATE
- 7 STOP-RH GATE OPEN RIDE THRU CLOSE BACK L INTO CHUTE-WALK OVER
- 8 END OF PATTERN

ANDBENNISDESIGN COPYRIGHT 2024
ALL RIGHTS RESERVED

VWB 8127 Novice Jugend Showmanship

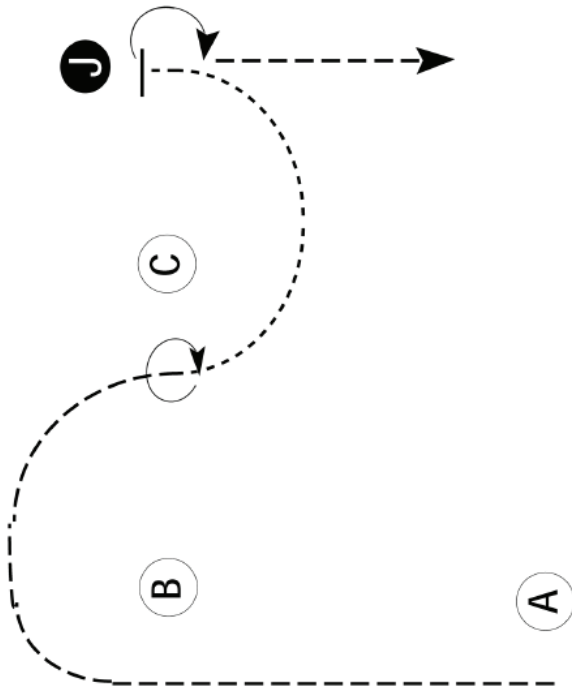

Be ready at A.

1. Trot from A around B and to C.
2. Stop and perform a 360 degree turn.
3. Walk to the Judge. Stop and set up for inspection.
4. When dismissed perform a 180 degree turn and trot straight away from the Judge.

NOTE: The drawn description of this pattern is only intended for the general depictions of the pattern.
Contestants should utilize the arena space to best exhibit their horses.

VWB 8128 Jugend Showmanship

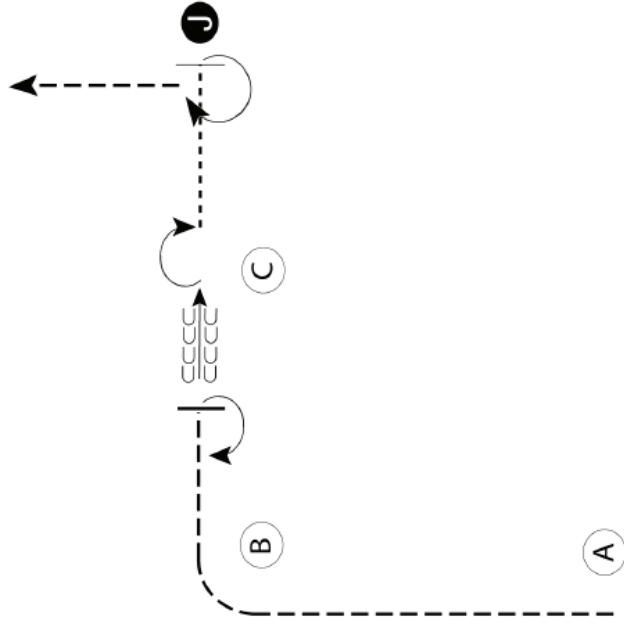

1. Jog from A around B.
2. Half way to C stop and perform a 180 degree turn.
3. Back to C.
4. Perform a 180 degree turn, walk to Judge and set up for inspection.
5. When dismissed perform a 270 degree turn and trot to lineup.

NOTE: The drawn description of this pattern is only intended for the general depictions of the pattern.
Contestants should utilize the arena space to best exhibit their horses.

VWB 9120 Einsteiger Showmanship
VWB 6810 Showmanship Jungpferde-Cup

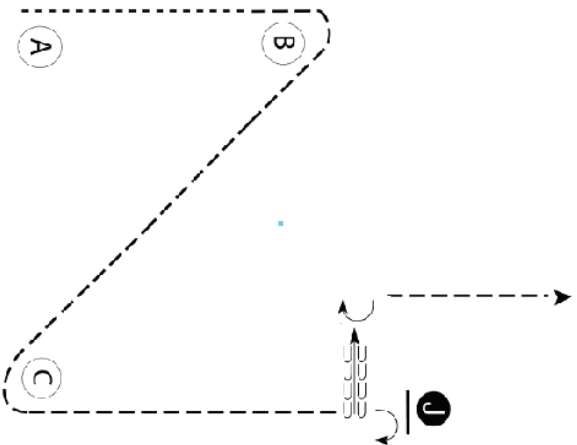

- Be ready at A.
1. Walk to B.
 2. Trot around B and C and straight to Judge.
 3. Stop and set up for inspection.
 4. When dismissed, turn 1/4 turn to the right.
 5. Back one horse length.
 6. Perform a 270 degree turn to the right.
 7. Trot straight away to finish.

NOTE: The drawn description of this pattern is only intended for the general depictions of the pattern. Contestants should utilize the arena space to best exhibit their horses.

VWB 7120 Amateur Showmanship
VWB 7128 Amateur Select Showmanship

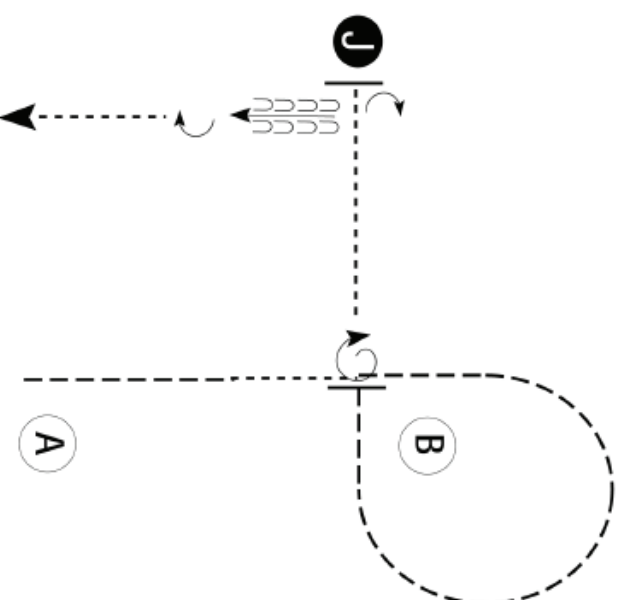

1. Trot halfway to B.
2. Walk two horse lengths.
3. Trot to and around B as shown.
4. Trot past B and stop. Perform a 360 degree turn.
5. Walk to judge and set up for inspection.
6. When dismissed, perform a 90 degree turn and back approximately 2 horse lengths.
7. Perform a 180 degree turn and walk straight away.

NOTE: The drawn description of this pattern is only intended for the general depictions of the pattern. Contestants should utilize the arena space to best exhibit their horses.

VWB-Shows in Kreuth 2024

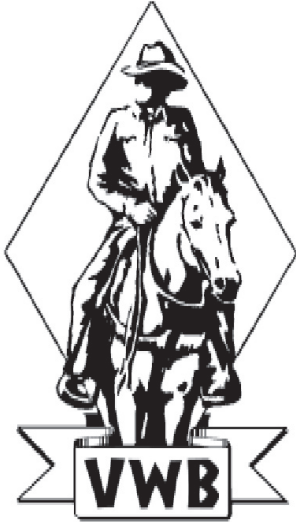

2. -7. Juli 2024

Bavarian Summer Show

- Bavarian Golden Series Finale -
- 18th NSBA European Championship -
- VWB Kat I-Show, 4-fach AQHA-Show -
- NRHA (USA) - Show -

19.-22. September 2024

Indian Summer Show

- VWB Kat I-Show, NRHA (USA) -Show -

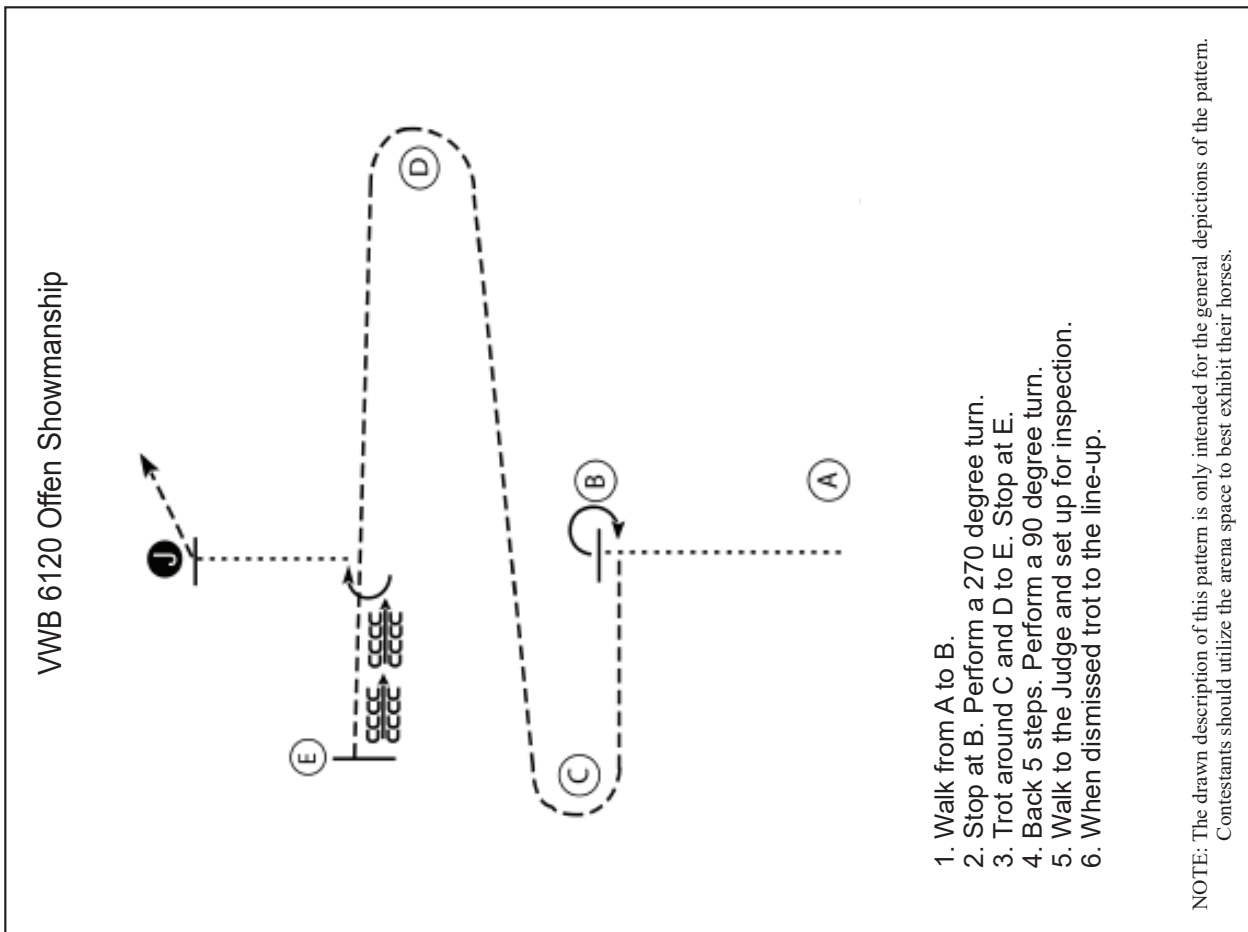

AQHA 4120 Youth Showmanship
AQHA 3120 Novice Amateur Showmanship

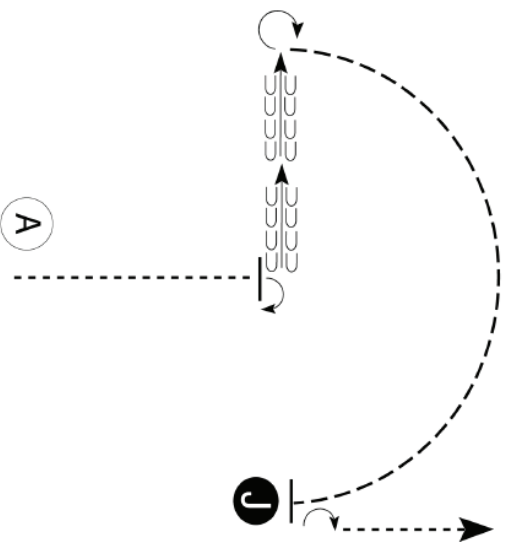

- Be ready at A.
1. When acknowledged, walk until horse's hip is even with Judge.
 2. Perform a 90 degree turn.
 3. Back approximately two horse lengths.
 4. Stop and perform a 270 degree turn.
 5. Trot in a half circle to Judge.
 6. Stop and set up for inspection.
 7. When dismissed, perform a 180 degree turn and walk straight away from Judge.

NOTE: The drawn description of this pattern is only intended for the general depictions of the pattern. Contestants should utilize the arena space to best exhibit their horses.

AQHA 2120 Amateur Showmanship

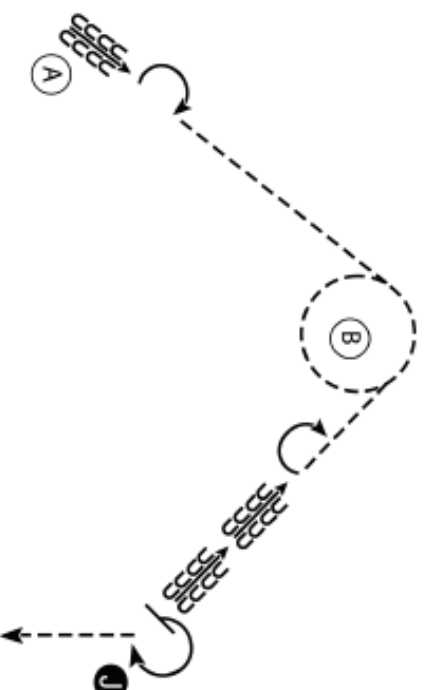

1. Begin at A. Back four steps and perform a 180 degree turn.
2. Trot to B.
3. Trot a circle around B.
4. Trot half way to the Judge.
5. Stop and perform a 180 degree turn. Back to the Judge.
6. Stop and set up for inspection.
7. When dismissed perform a 270 degree turn and trot straight away from the Judge.

NOTE: The drawn description of this pattern is only intended for the general depictions of the pattern. Contestants should utilize the arena space to best exhibit their horses.

VWB 8407 Novice Jugend Horsemanship

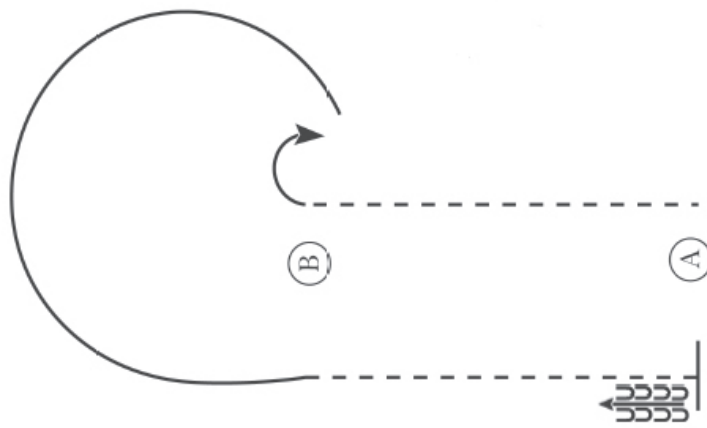

1. Jog to A to B.
2. At B perform a 90 degree turn to the right.
3. Lope a circle around B on the left lead.
4. At B jog to A.
5. Stop at A and back 4 steps.

NOTE: The drawn description of this pattern is only intended for the general depictions of the pattern.
Contestants should utilize the arena space to best exhibit their horses.

VWB 8408 Jugend Horsemanship
9400 VWB Einsteiger Horsemanship

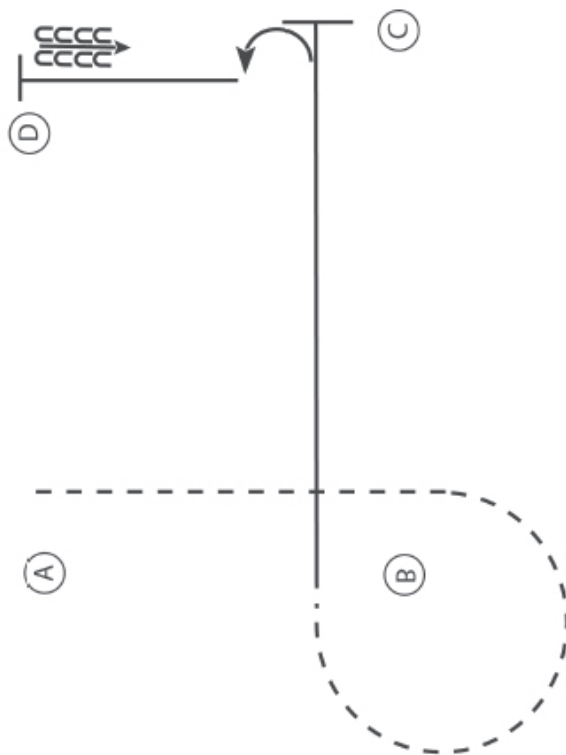

1. Jog von A nach und um B herum.
2. Bei B Rechtsgalopp nach C.
3. Stop bei C und 90 Grad Drehung nach links.
4. Linksgalopp nach D.
5. Stop bei D und 4 Tritte rückwärtsrichten.

NOTE: The drawn description of this pattern is only intended for the general depictions of the pattern.
Contestants should utilize the arena space to best exhibit their horses.

VWB 7400 Amateur Horsemanship
VWB 7408 Amateur Select Horsemanship

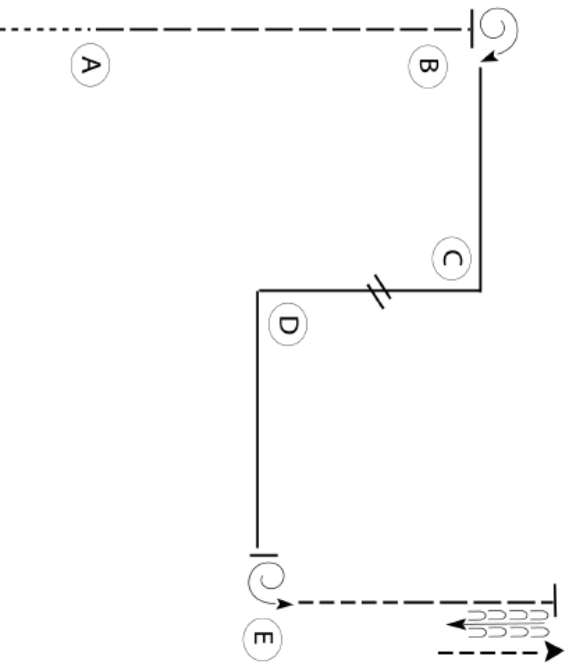

- Be ready before A.
1. Walk to A.
 2. Extend the jog from A past B.
 3. Stop and perform 2 1/4 spins to the right.
 4. Lope a square corner around C on the right lead.
 5. Perform a simple or flying lead change between C and D.
 6. Lope a square corner around D.
 7. Stop at E. Perform a 1 1/4 turn to the left.
 8. Jog half way to C. Extend the jog until 15 feet (4,5 meter) past C.
 9. Stop and back approximately one horse length.

NOTE: The drawn description of this pattern is only intended for the general depictions of the pattern. Contestants should utilize the arena space to best exhibit their horses.

5052 Bavarian Golden Series Showmanship

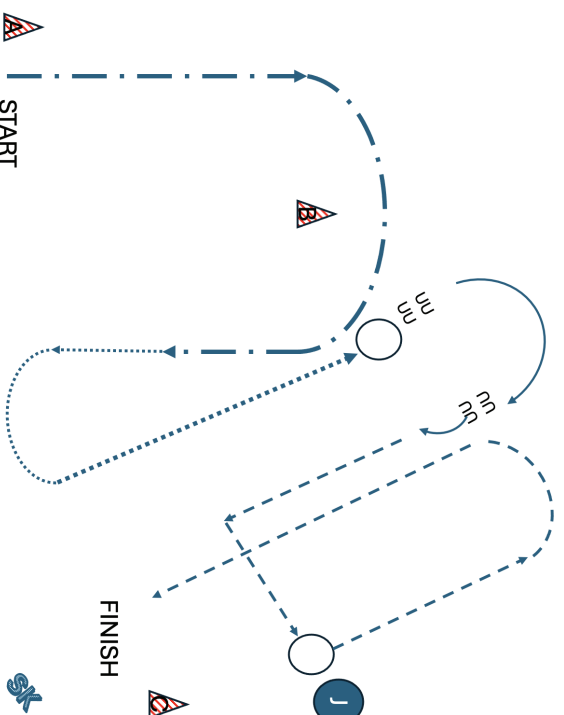

- Be ready at marker A
1. Extended trot around marker B as drawn
 2. Walk
 3. Extended walk back to centerline
 4. 1 1/2 turn
 5. Back as drawn
 6. 180° turn
 7. Trot and show 1 square corner, stop
 8. Set up
 9. Inspection
 10. 1 3/4 turn
 11. Trot as drawn and stop aligned with marker C
- Pattern completed, exit at the walk or trot

5054 Bavarian Golden Series Ranch Riding

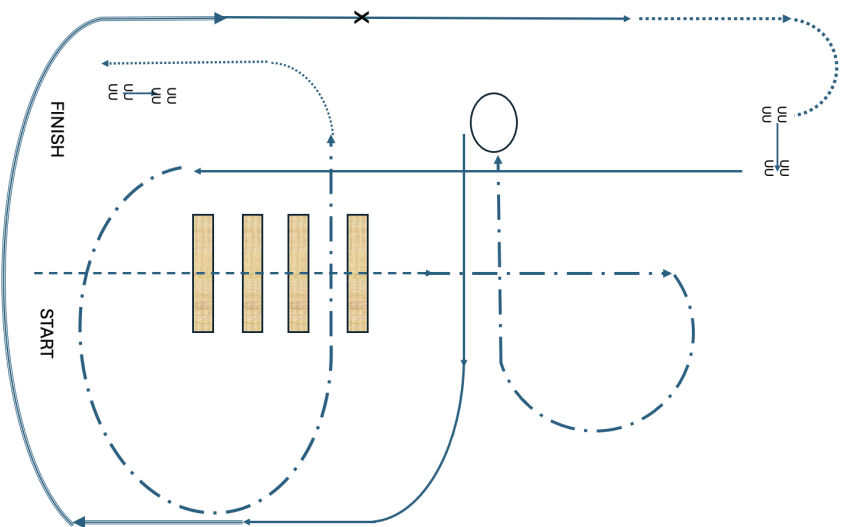

1. Trot and trot over logs
 2. Extended trot and stop
 3. 1 1/2 turn right or left
 4. Lope right lead
 5. Extended lope, collected lope
 6. Change leads
 7. Lope left lead
 8. Extended walk
 9. Sidepass
 10. Lope left lead
 11. Extended trot
 12. Walk
 13. Stop and back up
- Pattern completed

5053 Bavarian Golden Series Horsemanship

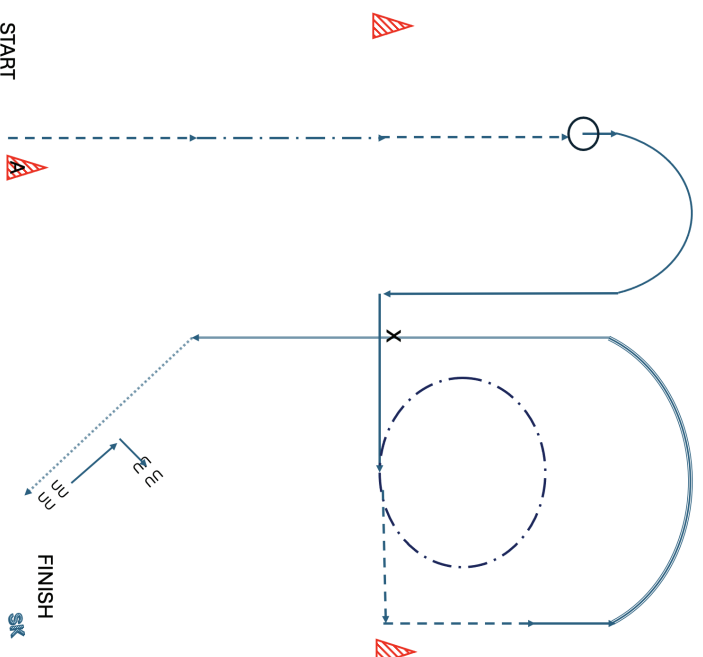

- Be ready at marker A
1. Jog, extended trot, jog, stop
 2. 360° turn each, either direction first
 3. Lope left lead (counter canter) and show 1 square corner
 4. Extended trot circle to the left
 5. Jog and show one square corner
 6. Left lead lope, extended lope, collected lope
 7. Change leads
 8. Right lead lope and continue down the centerline
 9. Transition to walk
 10. Back up as shown
- Pattern completed
Exit at the walk or jog

Die VWB - Bayerns größter Westernreitverein

Die Vereinigung der Westernreiter in Bayern e.V. wurde am 20.06.1982 gegründet. Heute - 42 Jahre später - ist mit über 1600 Mitgliedern aus der anfänglich kleinen Interessengemeinschaft der größte bayerische rasseoffene Westernreitverein geworden.

Es gibt viele Gründe bei uns Mitglied zu werden:

Günstige Kurse

Die VWB veranstaltet jährlich eine große Anzahl von Kursen, die von Profitrainern aus dem In- und Ausland abgehalten werden. Das Angebot umfasst sowohl Einsteiger- als auch Fortgeschrittenen-Kurse. Neben den allgemeinen Grundlagenkursen werden auch Spezialkurse für verschiedene Turnierdisziplinen angeboten.

Turniere jeder Größenordnung

Die VWB veranstaltet jährlich drei große Turniere, die mit teilweise 300-400 Pferden europaweit zu den bestbesuchten Westernturnieren zählen. Neben den großen Turnieren unterstützen wir Mitglieder, die kleinere Turniere organisieren, so dass den VWB-Mitgliedern eine breite Palette von jährlich 10-15 Turnieren zur Verfügung steht, an denen sie teilnehmen können.

Rasseoffen

In VWB-Klassen und auf VWB-Veranstaltungen kann jedes Pferd starten, wir sind offen für alle Rassen und auch für Pferde ohne Abstammungsnachweis.

Jugendarbeit

Kostengünstige Kurse und das sog. JuTu bilden die Grundlage unseres Jugendprogramms. Das JuTu ist unser Jugendturnier bei dem nur jugendliche Turniereulinge starten dürfen. Auf den großen Turnieren werden die Jugendklassen in Einsteiger (Novice Jugend) und fortgeschrittene Jugendklassen unterteilt, so dass jeder Jugendliche entsprechend seinem Leistungsniveau reiten kann. Darüber hinaus bezuschusst die VWB die Turnierboxen der Jugendlichen mit je 50 Euro pro Kat I -Turnier.

Quarter Horse Journal inklusive

Unsere Vollmitglieder erhalten monatlich neueste Informationen über das Westernreiten durch unsere Mitgliederzeitschrift ‚Quarter Horse Journal‘. Das QH-Journal beschäftigt sich neben der aktuellen Sportberichterstattung mit allen Themen rund ums Western- und Freizeitreiten, Zucht, Haltung und Lifestyle.

www.westernreiten-online.de

Darüber hinaus bietet die VWB auf ihrer Internetseite (www.westernreiten-online.de) aktuelle Informationen über Turniere, Kurse und andere News.

Weitere Infos und Anträge gibt's bei der VWB-Geschäftsstelle

Corrie Fuhr, Einzelhausen 22, 84104 Einzelhausen

Tel: 08752-2919876, e-mail: office@westernreiten-online.de



AQHA 3520 Novice Amateur Hunt Seat Equitation
 AQHA 4520 Youth Hunt Seat Equitation

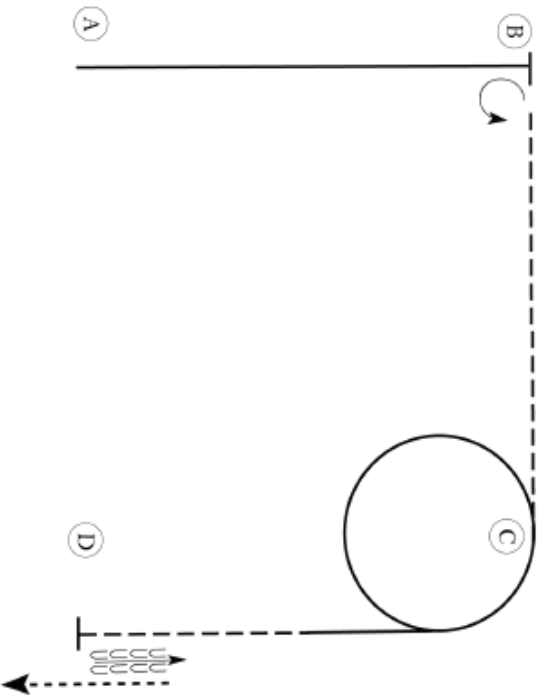

1. Canter on the left lead to B.
2. Stop at B and execute a 270 degree turn on the haunches to the left.
3. Posting trot on the right diagonal to C.
4. Canter on the right lead in a circle around C.
5. Continue on the right lead halfway to D.
6. Posting trot on the left diagonal to D.
7. Stop at D and back approximately one horse length.
8. Walk forward to and past D.

NOTE: The drawn description of this pattern is only intended for the general depictions of the pattern. Contestants should utilize the arena space to best exhibit their horses.

AQHA 2520 Amateur Hunt Seat Equitation

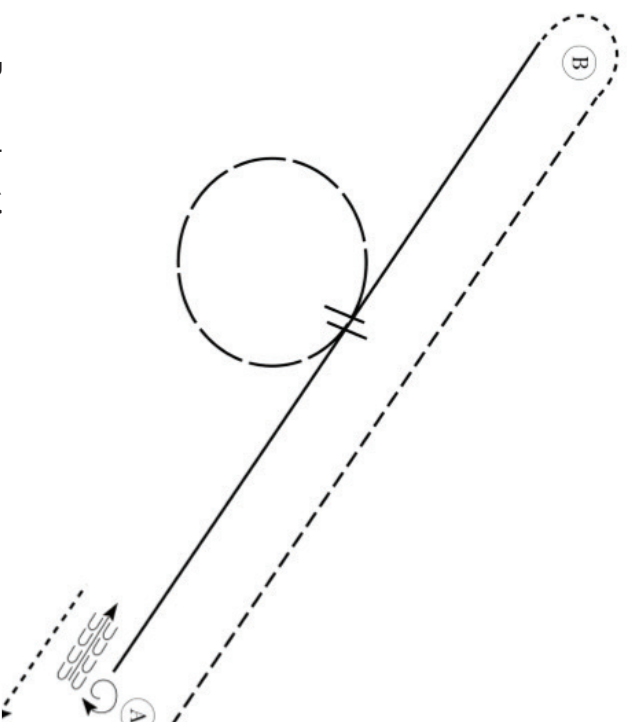

- Be ready at A.
1. Posting trot on the left diagonal halfway to B.
 2. Change diagonals and trot to B.
 3. Break to the walk and walk around B.
 4. Canter on the right lead halfway to A.
 5. Extend the canter in a circle to the right.
 6. Perform a simple lead change and canter to A.
 7. Halt at A and perform a 360 degree turn on the forehand to the right.
 8. Back approximately on horse length. Pattern is over once you have backed. Walk off.

NOTE: The drawn description of this pattern is only intended for the general depictions of the pattern. Contestants should utilize the arena space to best exhibit their horses.



VWB

Freestyle Reining

SPECIAL
WEEK

20%
auf
Allis

* vom 14. bis 21. Mai unter Social
and Events reduziert. Vorrat,
Vorn-Behring, Silber und 1000 1000



Danziger Str. 15
90556 Cadolzburg
Telefon 0171-7635831
shop.gomeler.com