

2. – 7. Juli 2024

Bavarian Summer

auf Gut Matheshof in Kreuth

Show

Golden Series Finale

45.000 Euro Preisgeld

4-fach AQHA-Show

NRHA (USA)-Show

NSBA-Show

VWB-Show

NSBA European Championship

Jungferde-Cup

3.000 Euro Preisgeld

55.000 Euro Gesamtpreisgeld

Nähere Infos unter



www.westernreiten-online.de

Veranstalter: Vereinigung der Westernreiter in Bayern e.V.



ART & Soul
Photography

Westernreiten

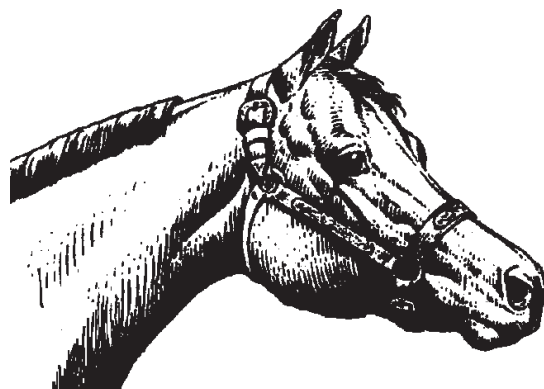

PATTERNBOOK

Bavarian Summer Show

2.-7. Juli 2024

Bavarian Golden Series Finals
NSBA-European Championship
NRHA (USA)-Show
VWB Kat I-Show
4-fach AQHA-Show

Aktuelle Show-Infos unter westernreiten-online.de

AMERICAN
QUARTER
HORSE
ASSOCIATION



Patternübersicht

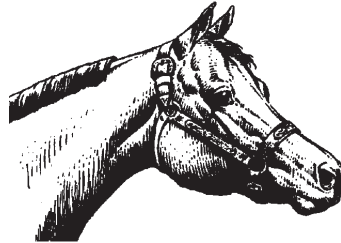

Reining

8347	VWB	Novice Jugend Reining	VWB-Pattern	5
8348	VWB	Jugend Reining	VWB-Pattern	13
9340	VWB	Einsteiger Reining	VWB-Pattern	15
7340	VWB	Amateur / Amateur Select Reining	VWB-Pattern	8
6340	VWB	Offen Reining	VWB-Pattern	11
5055	VWB	Bavarian Golden Series Reining	VWB-Pattern	12
1341	AQHA	Open Junior Reining	AQHA-Pattern	6
1342	AQHA	Open Senior Reining	AQHA-Pattern	15
1347	AQHA	Open Green Reining	AQHA-Pattern	14
2340	AQHA	Amateur Reining	AQHA-Pattern	6
3340	AQHA	Novice Amateur Reining	AQHA-Pattern	4
4340	AQHA	Youth Reining	AQHA-Pattern	6
1100	NRHA	Open Trophy	NRHA-Pattern	2
1700	NRHA	Novice Horse Open Level 1	NRHA-Pattern	8
1400	NRHA	Non Pro Trophy	NRHA-Pattern	17
1500	NRHA	Intermediate Non Pro	NRHA-Pattern	15
3100	NRHA	Youth 14-18	NRHA-Pattern	6
3200	NRHA	Youth 0-13	NRHA-Pattern	5

Western Riding

6360	VWB	Offen Western Riding	VWB-Pattern	9
7360	VWB	Amateur Western Riding	VWB-Pattern	9
9360	VWB	Einsteiger Western Riding	VWB-Pattern	7
5057	VWB	Bavarian Golden Series Western Riding	VWB-Pattern	7
1360	AQHA	Open Western Riding	AQHA-Pattern	1
1363	AQHA	Green Western Riding	Green-Pattern	L1-9
2360	AQHA	Amateur Western Riding	AQHA-Pattern	1
3360	AQHA	Novice Amateur Western Riding	AQHA-Pattern	L1-1

Ranch Riding

6430	VWB	Offen Ranch Riding	AQHA-Pattern	2
7430	VWB	Amateur / Amateur Select Ranch Riding	AQHA-Pattern	5
9430	VWB	Einsteiger Ranch Riding	AQHA-Pattern	8
8430	VWB	Jugend Ranch Riding	AQHA-Pattern	6
1430	AQHA	Open Ranch Riding	AQHA-Pattern	12
2430	AQHA	Amateur Ranch Riding	AQHA-Pattern	2
5054	VWB	Bavarian Golden Series Ranch Riding	Seite	21

Patternübersicht



Jungpferde

6840	VWB	Jungpferde-Reining	VWB-Pattern	2
6880	VWB	Jungpferde-Trail	VWB-Pattern	2
6890	VWB	Jungpferde-Basis	VWB-Pattern	2

Western Combination

6600	VWB	Western Combination Open	VWB-Pattern	2
------	-----	--------------------------	-------------	---

Trail

1381	AQHA	Open Junior Trail	Seite	8
1382	AQHA	Open Senior Trail	Seite	7
1383	AQHA	Green Trail	Seite	6
2380	AQHA	Amateur / Amateur Select Trail	Seite	7
3380	AQHA	Novice Amateur Trail	Seite	6
4380	AQHA	Youth Trail	Seite	10
6380	VWB	Offen Trail	Seite	9
6390	VWB	Offen Ranch Trail	Seite	9
6830	VWB	Offen Trail in Hand	Seite	10
7380	VWB	Amateur / Amateur Select Trail	Seite	12
7390	VWB	Amateur Ranch Trail	Seite	14
9380	VWB	Einsteiger Trail	Seite	13
8387	VWB	Novice Jugend	Seite	13
8388	VWB	Jugend	Seite	12
5050	VWB	Bavarian Golden Series Trail	Seite	11
5056	VWB	Bavarian Limited Series Trail	Seite	11
5006	NSBA	Oprn Trail in Hand	Seite	8

Showmanship

	VWB	alle Showmanship VWB	Seite	15 / 16
	AQHA	alle Showmanship AQHA	Seite	17
6810	VWB	Jungpferde-Cup	Seite	17
5052	VWB	Bavarian Golden Series Showmanship	Seite	14

Horsemanship

	VWB	alle Horsemanship VWB	Seite	18 / 19
	AQHA	alle Horsemanship AQHA	Seite	19 / 20
5053	VWB	Bavarian Golden Series Horsemanship	Seite	21

Hunt Seat Equitation

	AQHA	alle Hunt Seat Equitation AQHA	Seite	22
--	------	--------------------------------	-------	----

WEDNESDAY 3.7.2024

1383 AQHA GREEN OPEN

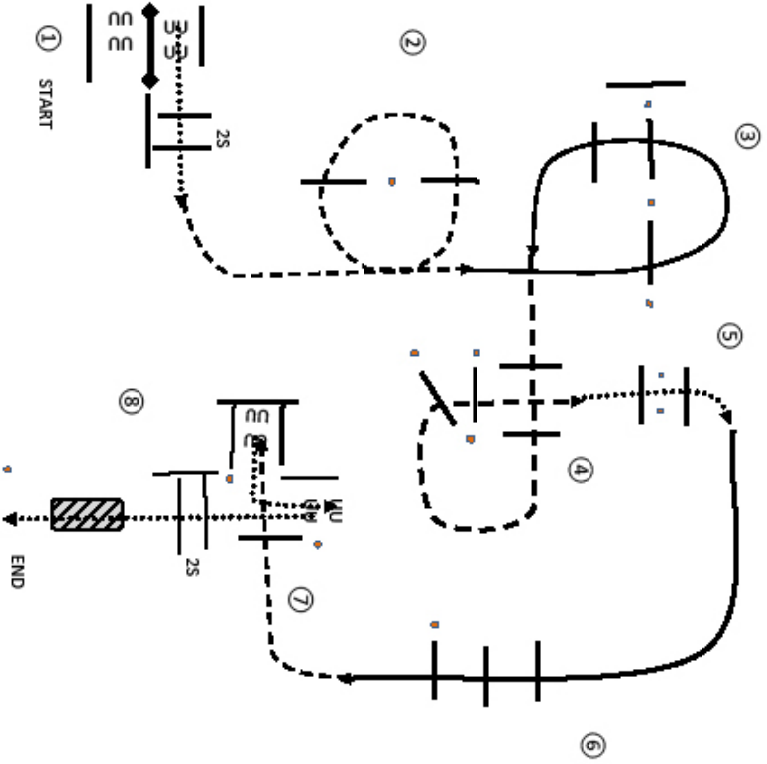

- 1 RH OPEN GATE RIDE THROUGH CLOSE-WALK OVERTS
 - 2 JOG OVERTS
 - 3 LL LOPE OVERTS
 - 4 JOG OVERTS
 - 5 STOP OR BREAK TO A WALK-WALK OVERTS
 - 6 RL LOPE OVERTS
 - 7 JOG OVERTS INTO CHUTE-STOP-BACK L INTO CHUTE
 - 8 WALK OVERTS-BRIDGE
- END OF PATTERN

ANNDENNISDESIGN COPYRIGHT 2024
ALL RIGHTS RESERVED

WEDNESDAY 3.7.2024

3380 AQHA NOVICE AMATEUR

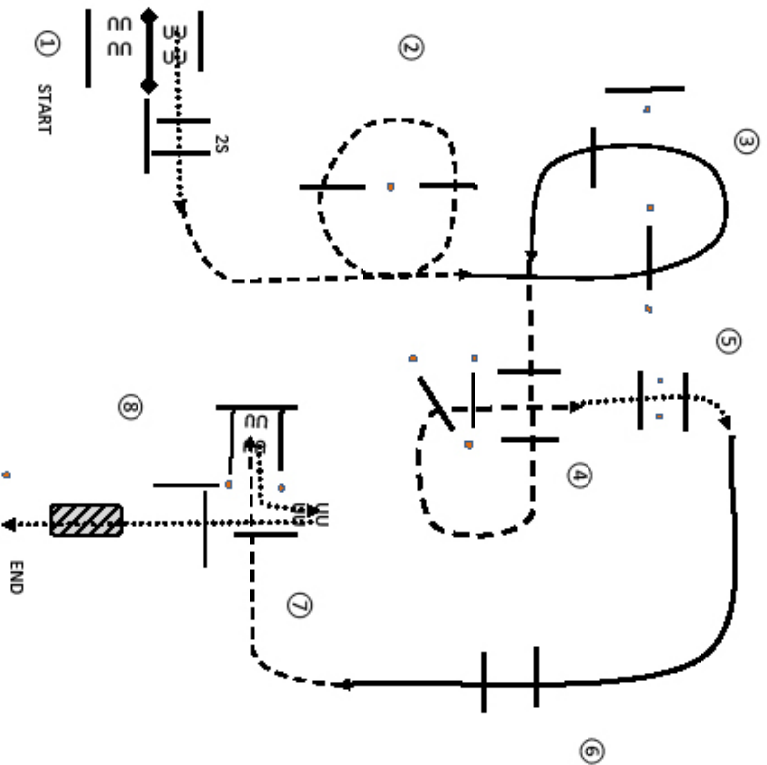

- 1 RH OPEN GATE RIDE THROUGH CLOSE-WALK OVERTS
 - 2 JOG OVERTS
 - 3 LL LOPE OVERTS
 - 4 JOG OVERTS
 - 5 STOP OR BREAK TO A WALK-WALK OVERTS
 - 6 RL LOPE OVERTS
 - 7 JOG OVERTS INTO CHUTE-STOP-BACK L INTO CHUTE
 - 8 WALK OVERTS-BRIDGE
- END OF PATTERN

ANNDENNISDESIGN COPYRIGHT 2024
ALL RIGHTS RESERVED

2380 AQHA AMATEUR
2388 AMATEUR SELECT

THURSDAY 4.7.2024

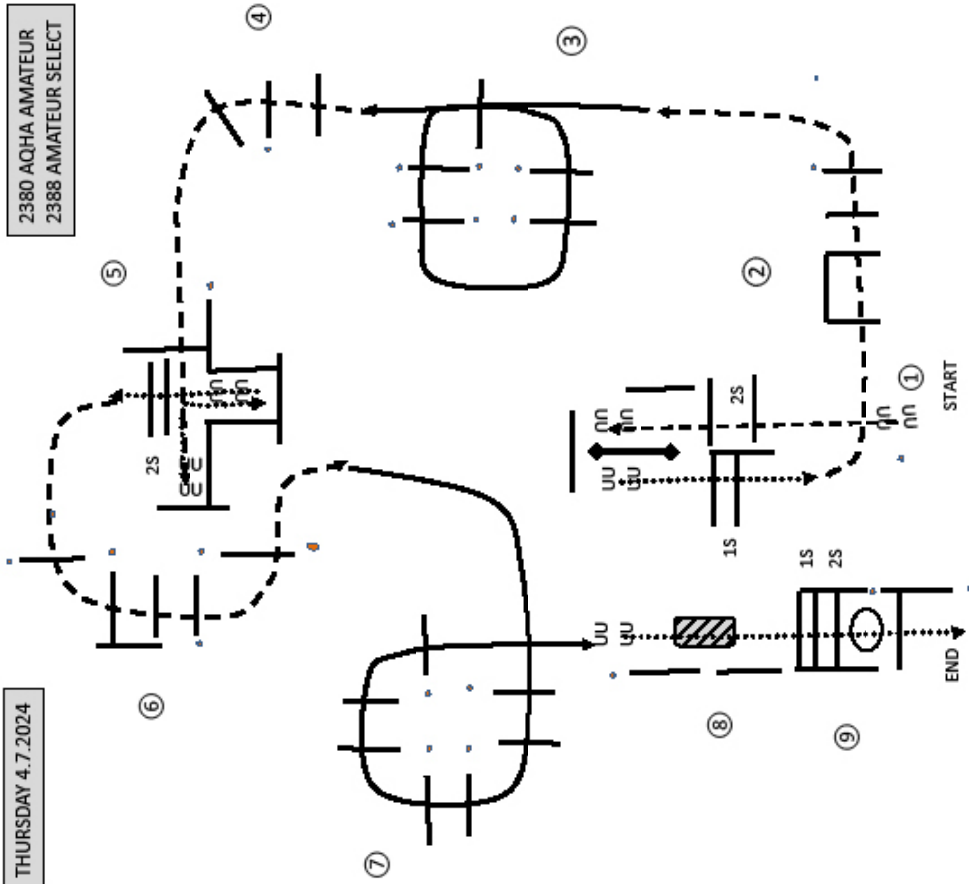

- 1 JOG OVERS THROUGH CHUTE STOP-LH OPEN GATE WALK THRU CLOSE-WALK OVERS
- 2 JOG OVERS
- 3 LL LOPE OVERS
- 4 JOG OVERS
- 5 JOG OVER INTO CHUTE-STOP-BACK L-WALK OVERS
- 6 JOG OVERS
- 7 RL LOPE OVERS
- 8 STOP OR BREAK TO A WALK-BRIDGE-WALK OVERS
- 9 360 TURN EITHER WAY IN BOX-WALK OVER TO EXIT

ANNDENNISDESIGN COPYRIGHT 2024
ALL RIGHTS RESERVED

1382 AQHA SR TRAIL

THURSDAY 4.7.2024

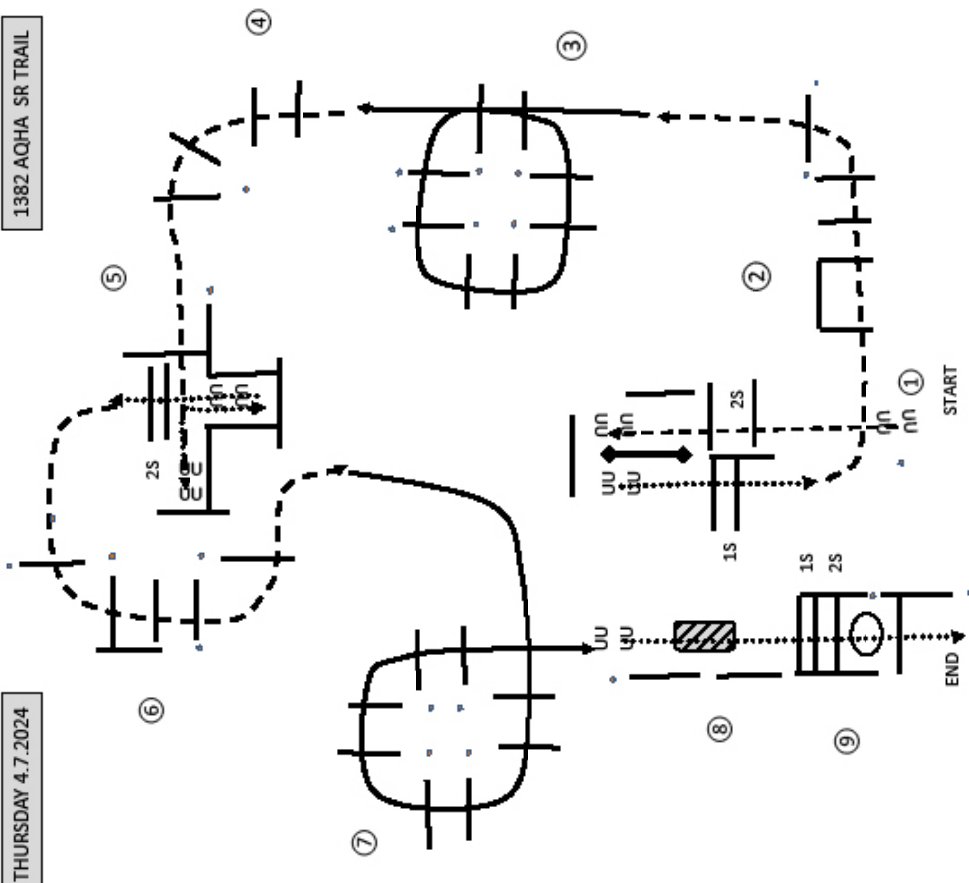

- 1 JOG OVERS THROUGH CHUTE STOP-LH OPEN GATE WALK THRU CLOSE-WALK OVERS
- 2 JOG OVERS
- 3 LL LOPE OVERS
- 4 JOG OVERS
- 5 JOG OVER INTO CHUTE-STOP-BACK L-WALK OVERS
- 6 JOG OVERS
- 7 RL LOPE OVERS
- 8 STOP OR BREAK TO A WALK-BRIDGE-WALK OVERS
- 9 360 TURN EITHER WAY IN BOX-WALK OVER TO EXIT

ANNDENNISDESIGN COPYRIGHT 2024
ALL RIGHTS RESERVED

THURSDAY 4.7.2024

1381 AQHA JR HORSE

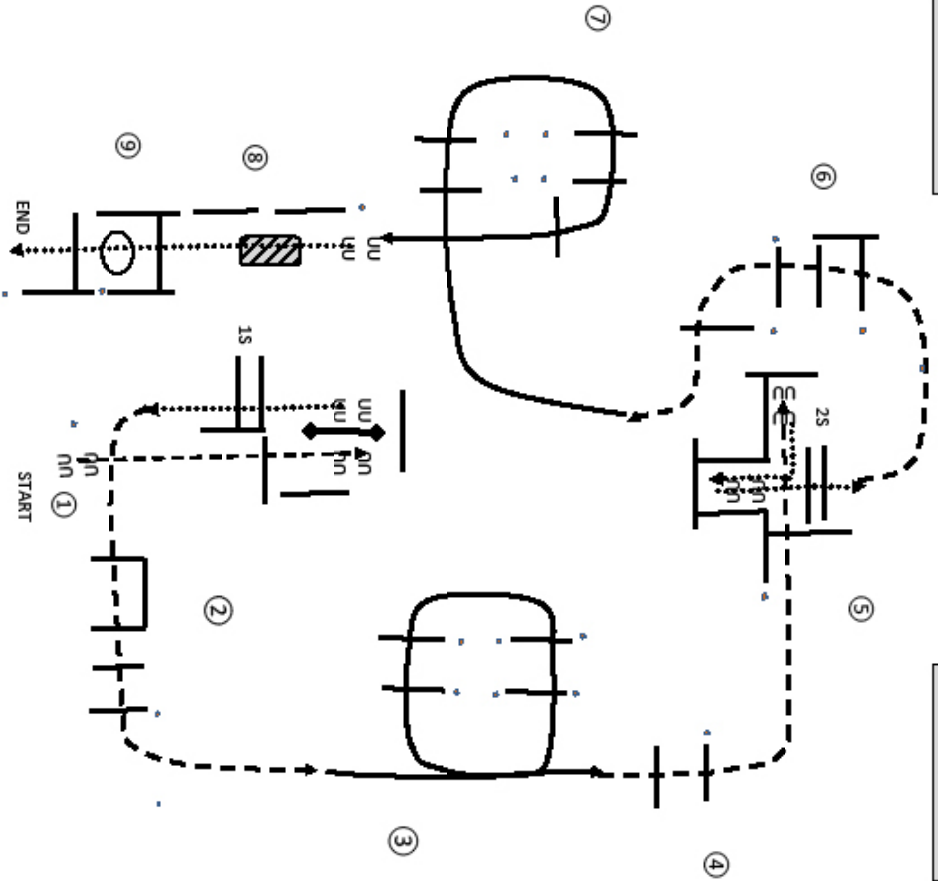

- 1 JOG OVER THROUGH CHUTE STOP-LH OPEN GATE WALK THRU CLOSE-WALK OVERS
- 2 JOG OVERS
- 3 LL LOPE OVERS
- 4 JOG OVERS
- 5 JOG OVER INTO CHUTE-STOP-BACK L-WALK OVERS
- 6 JOG OVERS
- 7 RL LOPE OVERS
- 8 STOP OR BREAK TO A WALK-BRIDGE-WALK OVER
- 9 360 TURN EITHER WAY IN BOX-WALK OVER TO EXIT

ANNDENNISDESIGN COPYRIGHT 2024
ALL RIGHTS RESERVED

THURSDAY 4.7.2024

5006 TRAIL IN HAND NSBA

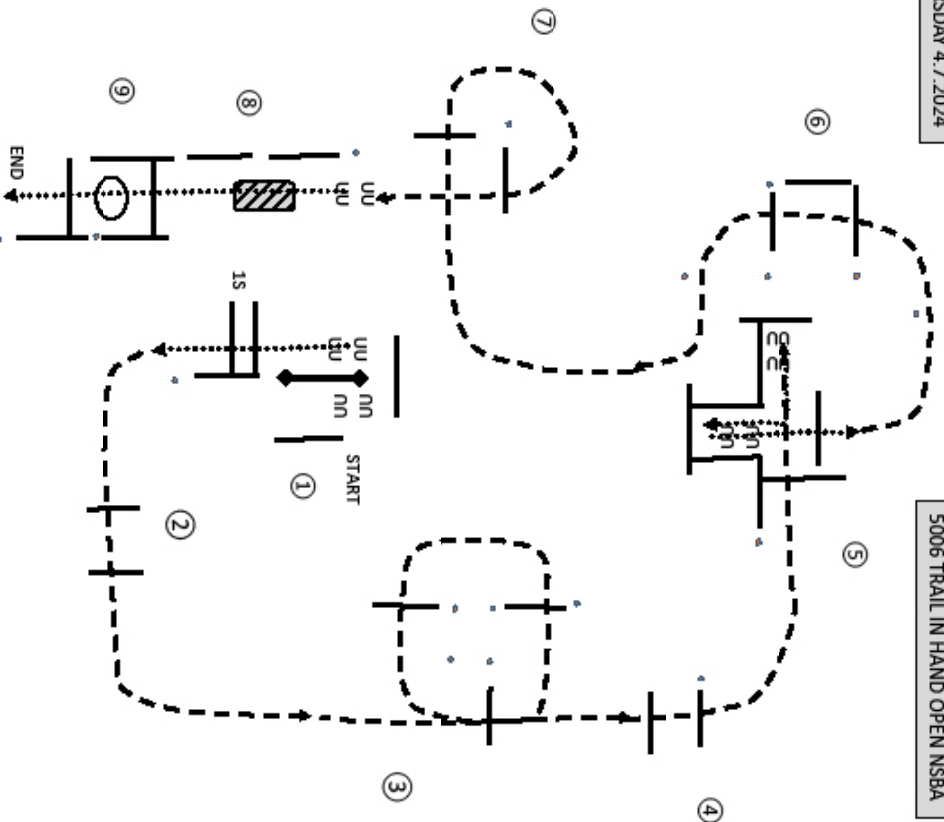

- 1 LH OPEN GATE WALK THRU CLOSE-WALK OVERS
- 2 TROT OVERS
- 3 CIRCLE TROT OVERS
- 4 TROT OVERS
- 5 TROT OVER INTO CHUTE-STOP-BACK L-WALK OVERS
- 6 TROT OVERS
- 7 TROT OVERS
- 8 STOP OR BREAK TO A WALK-BRIDGE-WALK OVER
- 9 360 RIGHT IN BOX-WALK OVER TO EXIT

ANNDENNISDESIGN COPYRIGHT 2024
ALL RIGHTS RESERVED

THURSDAY 4.7.2024

6390 VWB RANCH TRAIL OPEN

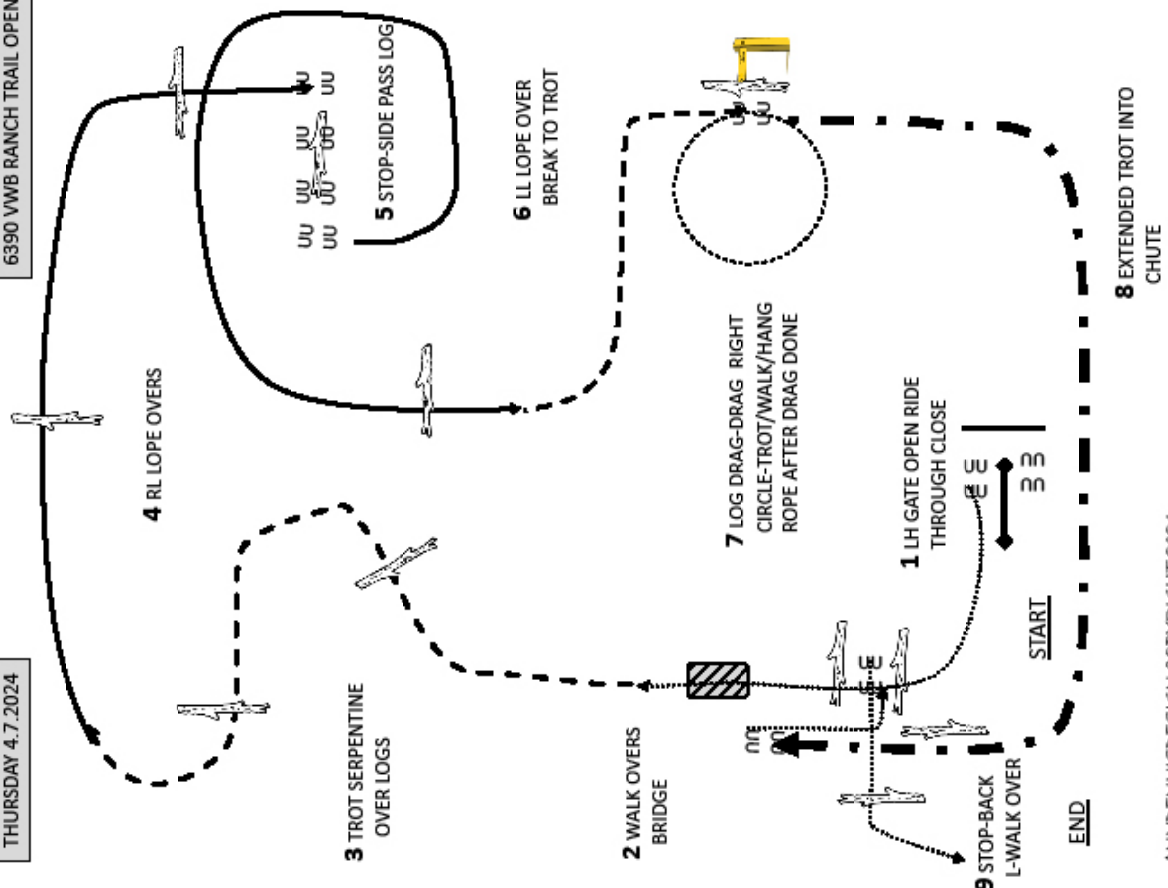

ANNDENISDESIGN COPYRIGHT 2024
ALL RIGHTS RESERVED

FRIDAY 5.7.2024

6380 VWB TRAIL ALL AGES OFFEN

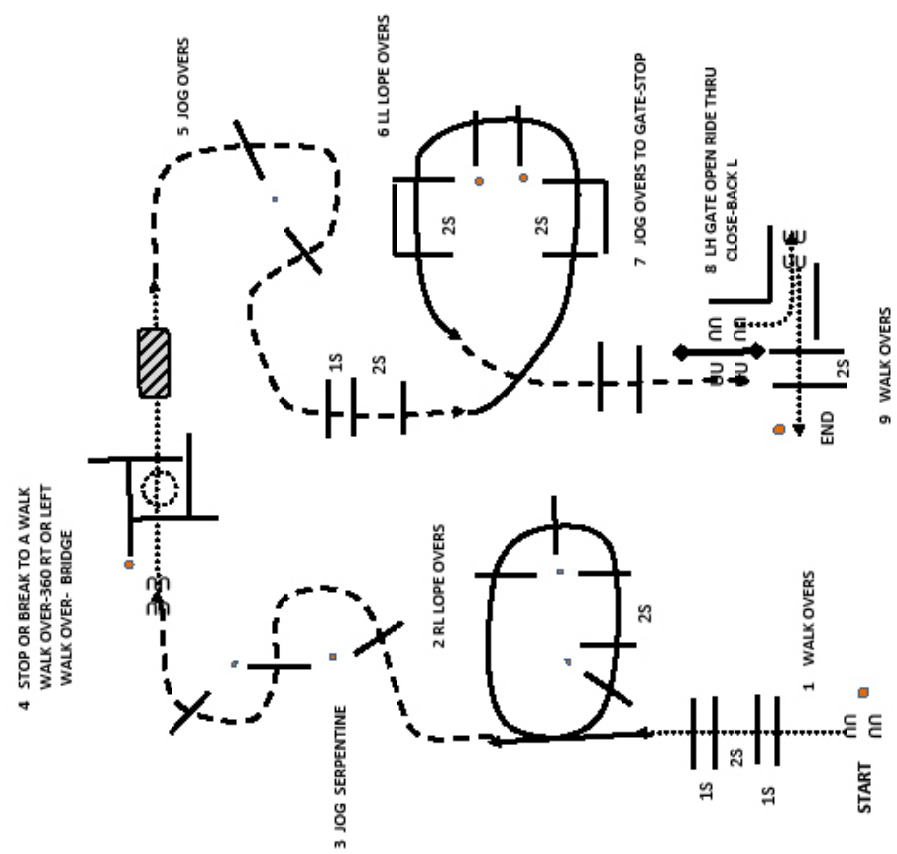

ANNDENISDESIGN COPYRIGHT 2024
ALL RIGHTS RESERVED

FRIDAY 5.7.2024

4380 AQHA YOUTH TRAIL

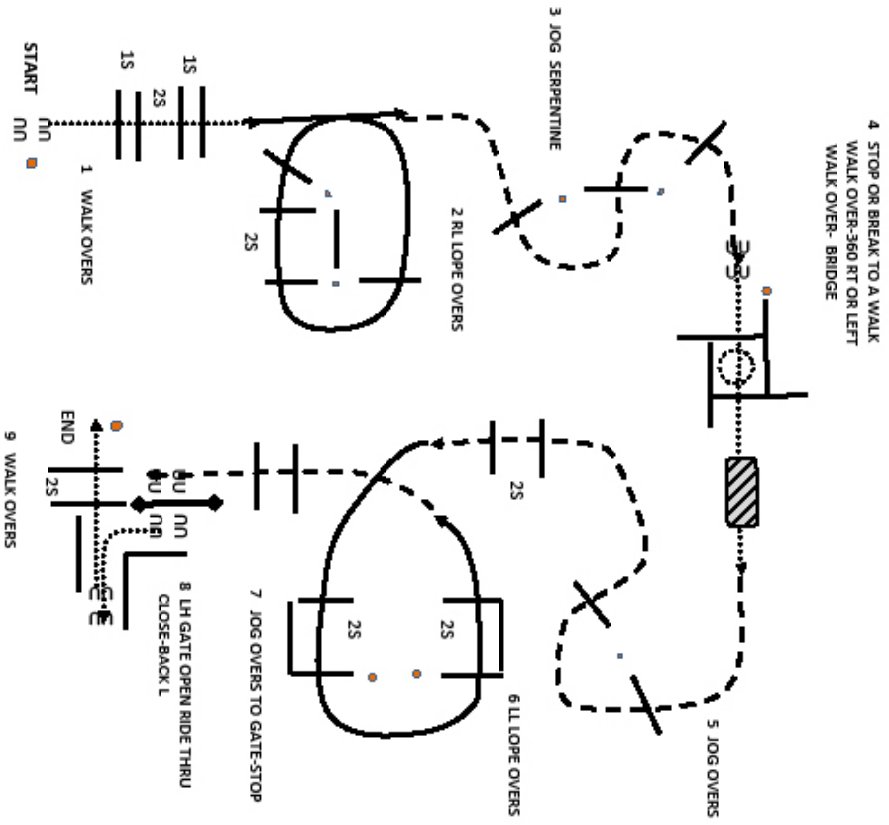

ANNBENNISDESIGN COPYRIGHT 2024
ALL RIGHTS RESERVED

FRIDAY 5.7.2024

6830 VWB JUNGPERDE-CUP IN HAND TRAIL

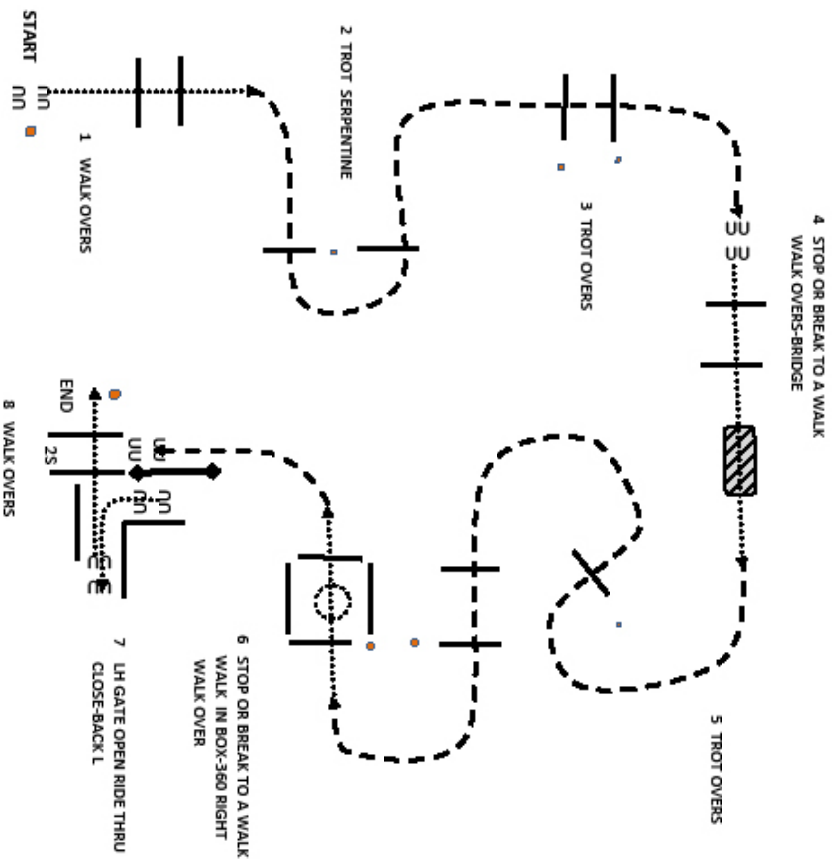

ANNBENNISDESIGN COPYRIGHT 2024
ALL RIGHTS RESERVED

5056 LIMITED SERIES TRAIL FINALE

SATURDAY 6.7.2024

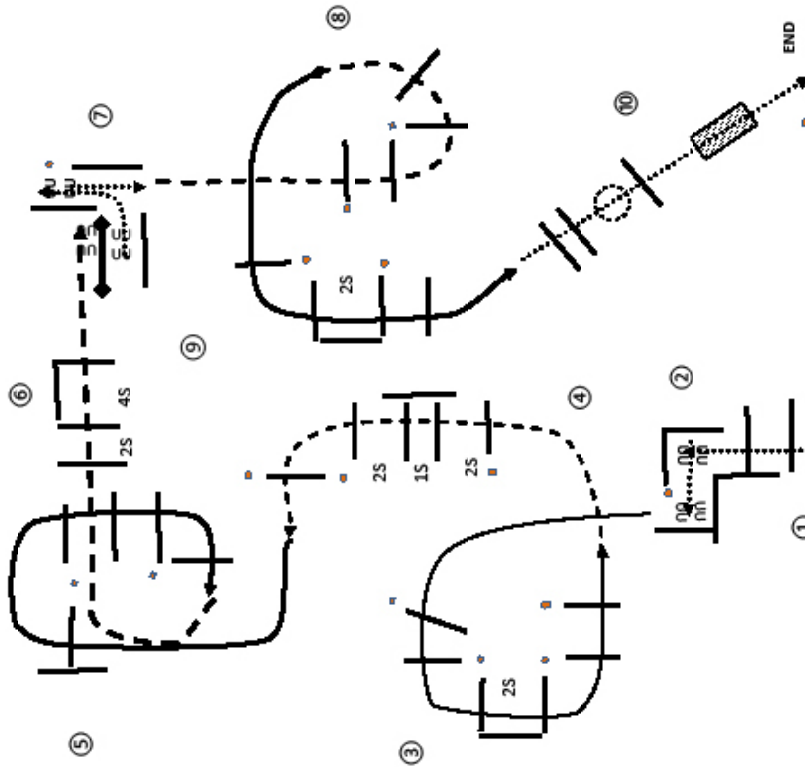

- 1 WALK OVERS-STOP
 - 2 SIDE PASS LEFT-LL LOPE OUT
 - 3 LL LOPE OVERS
 - 4 JOG OVERS
 - 5 RL LOPE OVERS
 - 6 JOG THROUGH CHUTE OVER POLES TO GATE STOP
 - 7 RH GATE OPEN WALK OVER POLE CLOSE -BACK L INTO CHUTE-WALK A FEW STEPS-JOG
 - 8 JOG OVERS
 - 9 LL LOPE OVERS
 - 10 STOP OR BREAK TO A WALK-WALK OVER -360 R OR L-WALK OVERS -BRIDGE
- END OF PATTERN

ANNDENNISDESIGN COPYRIGHT 2024
ALL RIGHTS RESERVED

5050 GOLDEN SERIES TRAIL FINALE

SATURDAY 6.7.2024

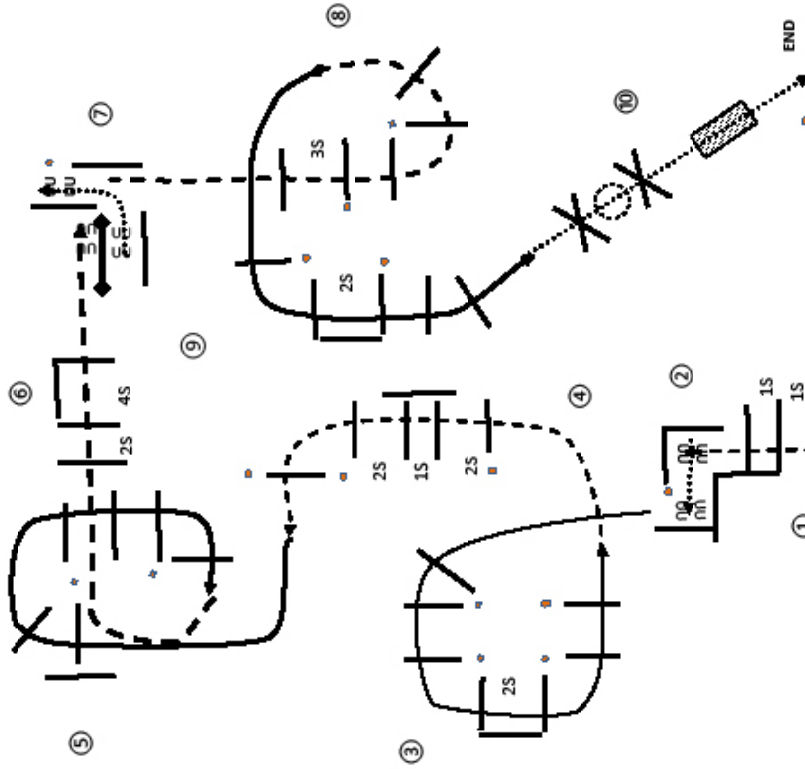

- 1 JOG OVERS-STOP
 - 2 SIDE PASS LEFT-LL LOPE OUT
 - 3 LL LOPE OVERS
 - 4 JOG OVERS
 - 5 RL LOPE OVERS
 - 6 JOG THROUGH CHUTE OVER POLES TO GATE STOP
 - 7 RH GATE OPEN WALK OVER POLE CLOSE -BACK L INTO CHUTE-JOG OUT
 - 8 JOG OVERS
 - 9 LL LOPE OVERS
 - 10 STOP OR BREAK TO A WALK-WALK OVER X-360 R OR L-WALK OVER X-BRIDGE
- END OF PATTERN

ANNDENNISDESIGN COPYRIGHT 2024
ALL RIGHTS RESERVED

SUNDAY 7.7.24

7380 VWB AMATEUR
7388 VWB AMATEUR SELECT

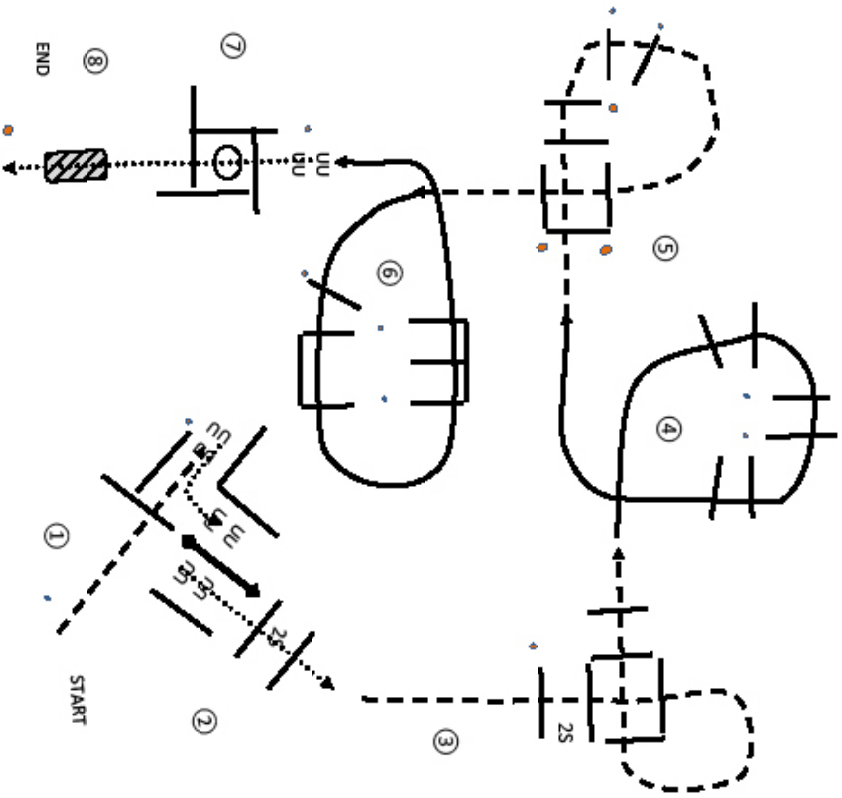

- 1 JOG OVER INTO CHUTE-STOP-BACK L TO GATE
- 2 LH GATE OPEN WALK THROUGH CLOSE GATE--WALK OVERS
- 3 JOG OVERS
- 4 RL LOPE OVERS
- 5 JOG OVERS
- 6 LL LOPE OVERS
- 7 STOP OR BREAK TO A WALK-WALK OVER-360 R OR L-WALK OVER
- 8 BRIDGE-END OF PATTERN

ANNDENNISDESIGN COPYRIGHT 2024
ALL RIGHTS RESERVED

SUNDAY 7.7.24

8388 VWB JUGEND

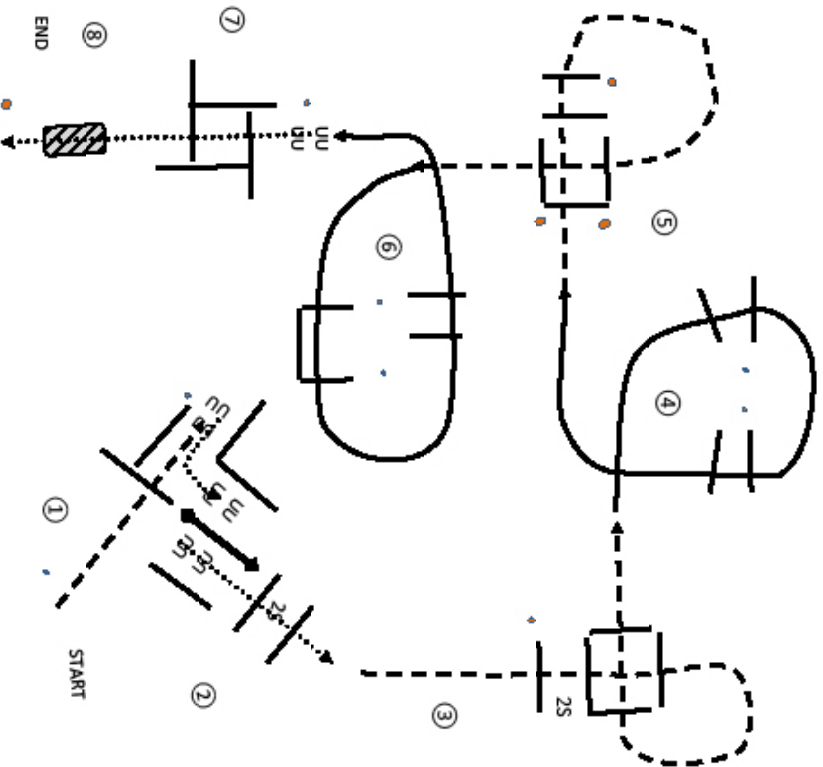

- 1 JOG OVER INTO CHUTE-STOP-BACK L TO GATE
- 2 LH GATE OPEN WALK THROUGH CLOSE GATE--WALK OVERS
- 3 JOG OVERS
- 4 RL LOPE OVERS
- 5 JOG OVERS
- 6 LL LOPE OVERS
- 7 STOP OR BREAK TO A WALK-WALK OVERS
- 8 BRIDGE-END OF PATTERN

ANNDENNISDESIGN COPYRIGHT 2024
ALL RIGHTS RESERVED

8387 VWB NOVICE JUGEND

SUNDAY 7.7.24

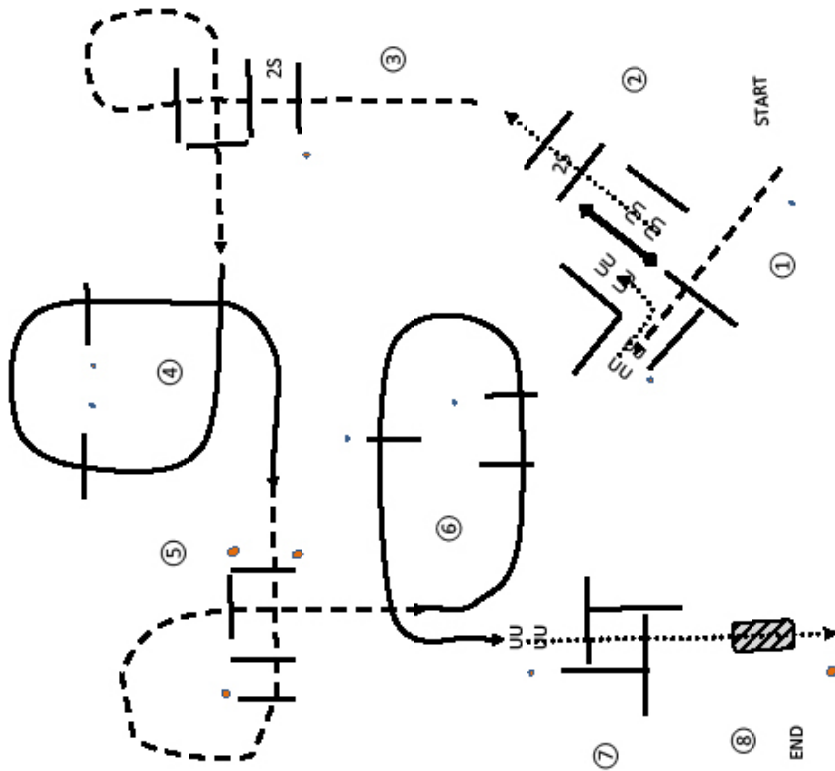

- 1 JOG OVER INTO CHUTE-STOP-BACK L TO GATE
- 2 LH GATE OPEN WALK THROUGH CLOSE GATE--WALK OVERS
- 3 JOG OVERS
- 4 RL LOPE OVERS
- 5 JOG OVERS
- 6 LL LOPE OVERS
- 7 STOP OR BREAK TO A WALK-WALK OVERS
- 8 BRIDGE-END OF PATTERN

ANNDENNISDESIGN COPYRIGHT 2024
ALL RIGHTS RESERVED

SUNDAY 7.7.24

9380 VWB EINSTEIGER

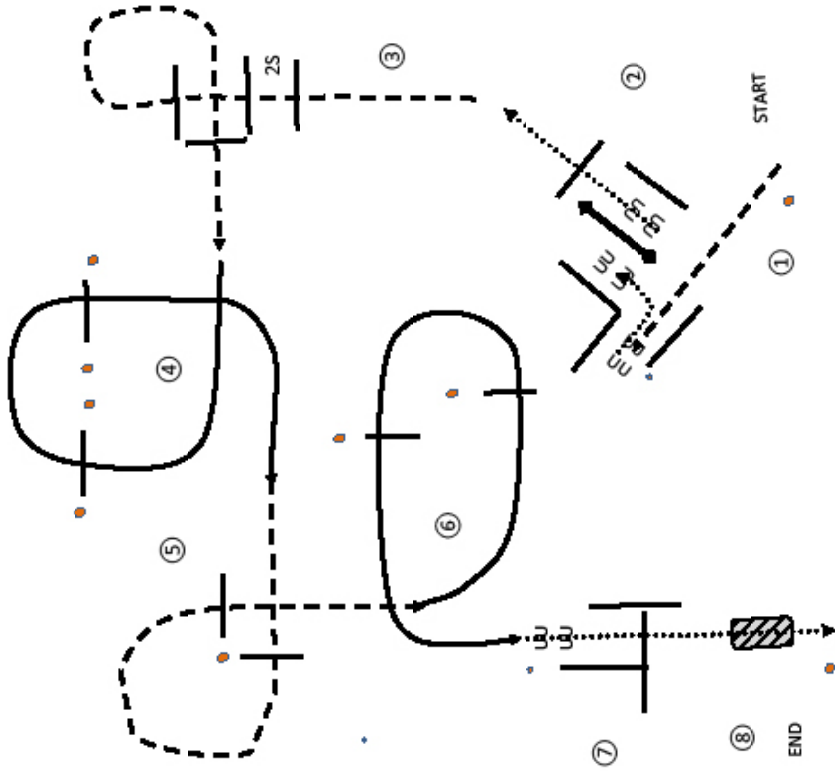

- 1 JOG INTO CHUTE-STOP-BACK L TO GATE
- 2 LH GATE OPEN WALK THROUGH CLOSE GATE--WALK OVER
- 3 JOG OVERS
- 4 RL LOPE OVERS
- 5 JOG OVERS
- 6 LL LOPE OVERS
- 7 STOP OR BREAK TO A WALK-WALK OVERS
- 8 BRIDGE-END OF PATTERN

ANNDENNISDESIGN COPYRIGHT 2024
ALL RIGHTS RESERVED

SUNDAY 7.7.24

7390 VWB RANCH TRAIL AMATEUR

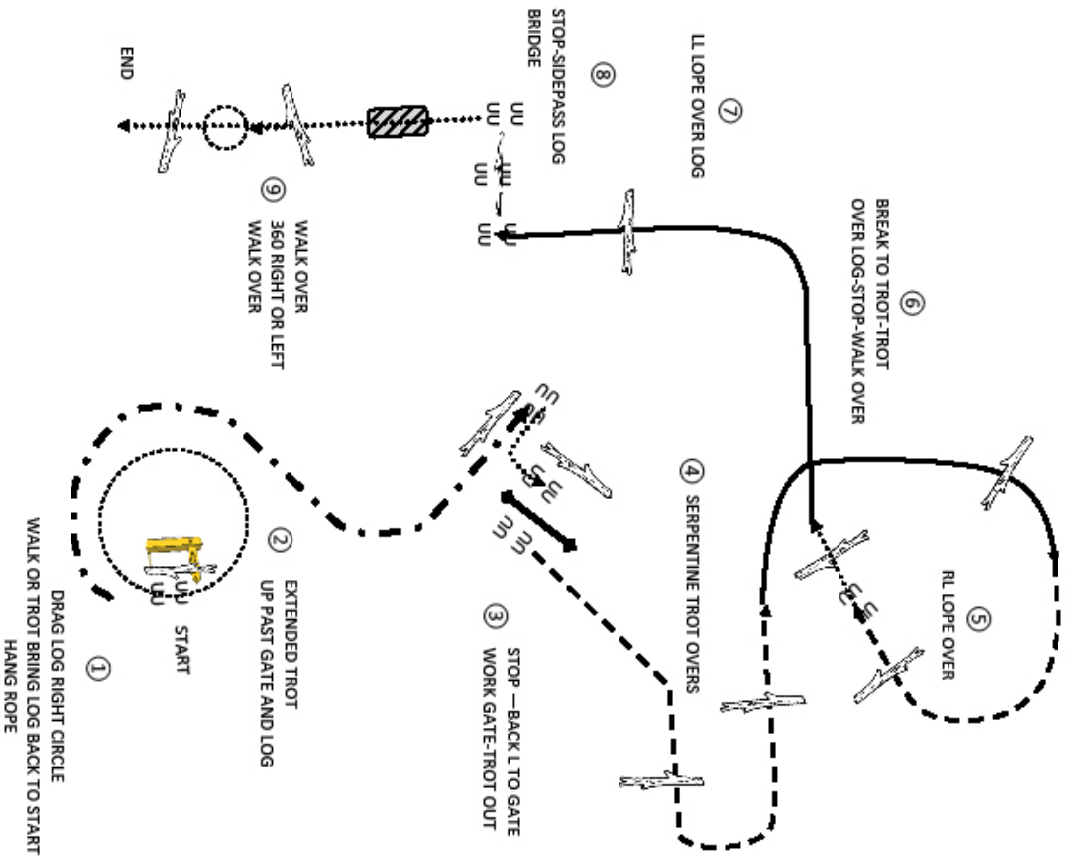

AN DENNIS DESIGN COPYRIGHT 2024
ALL RIGHTS RESERVED

5052 Bavarian Golden Series Showmanship

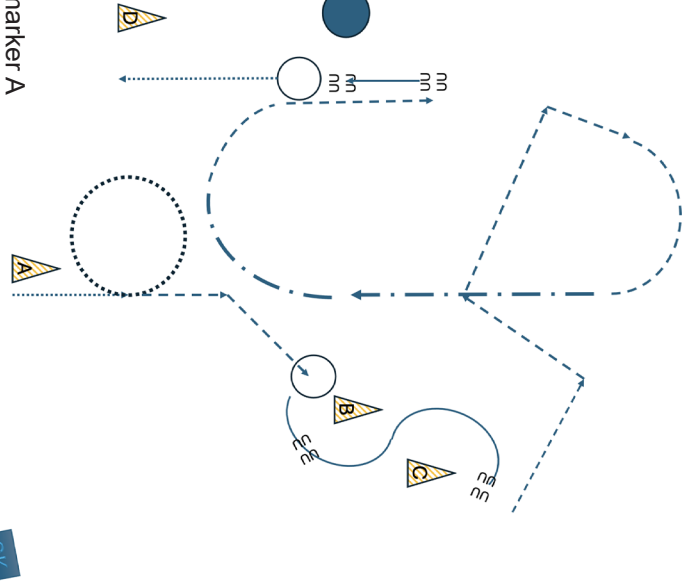

- Be ready at marker A
1. Walk
 2. Extended walk and show a circle to the left
 3. Trot as drawn, stop
 4. Approx. 1 3/4 turn
 5. Back through
 6. Trot and show 3 square corners
 7. Extended trot down the centerline and 1/2 of the arc
 8. Trot and stop past the judge
 9. Back approx. 2 horse lengths and stop aligned with horse's hip with the judge
 10. Set up
 11. Inspection
 12. 1 1/2 turn
 13. Walk and stop at D
- Pattern completed

VWB 8127 Novice Jugend Showmanship
 VWB 9120 Einsteiger Showmanship

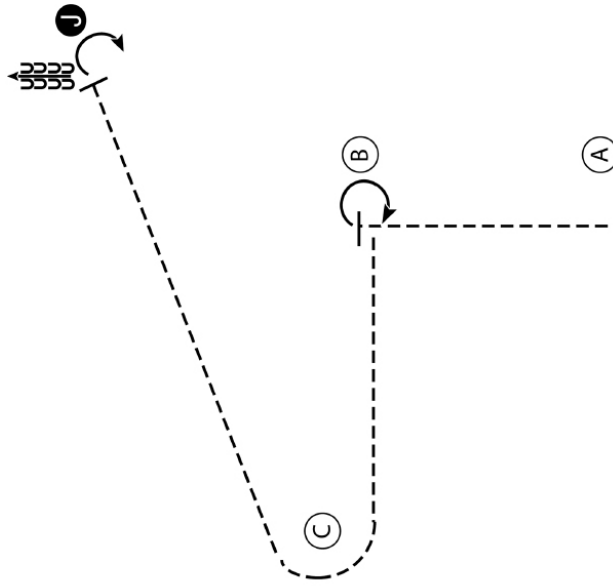

1. Trot from A to B.
2. Stop and perform a 270 degree turn.
3. Trot from B, around C, to the Judge.
4. Stop and set up for inspection.
5. When dismissed perform a 110 degree turn.
6. Back six steps and follow instructions from ring steward.

NOTE: The drawn description of this pattern is only intended for the general depictions of the pattern. Contestants should utilize the arena space to best exhibit their horses.

VWB 8128 Jugend Showmanship

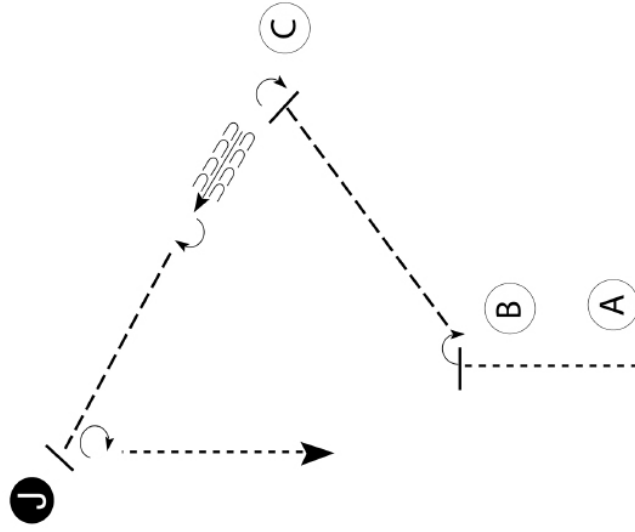

- Be ready at A.
1. Walk to B.
 2. Stop and pivot to the right.
 3. Trot to C.
 4. Perform a 90 degree turn.
 5. Back approximately one horse length.
 6. Perform a 180 degree turn.
 7. Trot to judge.
 8. Stop and set up for inspection.
 9. When dismissed, perform a 225 degree turn.
 10. Walk straight away from judge.

NOTE: The drawn description of this pattern is only intended for the general depictions of the pattern. Contestants should utilize the arena space to best exhibit their horses.

VWB 7120 Amateur Showmanship
VWB 7128 Amateur Select Showmanship

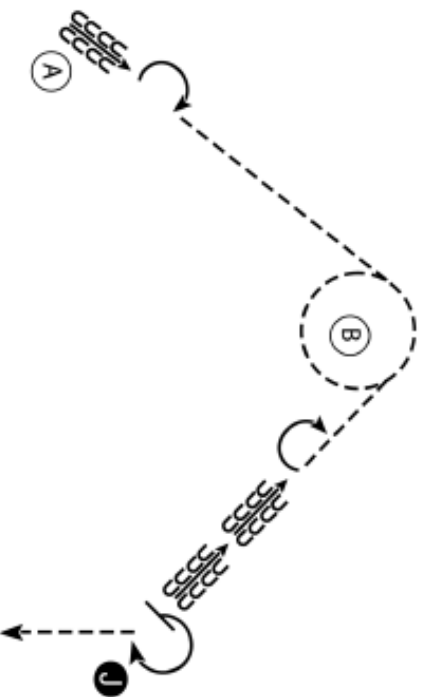

1. Begin at A. Back four steps and perform a 180 degree turn.
2. Trot to B.
3. Trot a circle around B.
4. Trot half way to the Judge.
5. Stop and perform a 180 degree turn. Back to the Judge.
6. Stop and set up for inspection.
7. When dismissed perform a 270 degree turn and trot straight away from the Judge.

NOTE: The drawn description of this pattern is only intended for the general depictions of the pattern. Contestants should utilize the arena space to best exhibit their horses.

VWB 6120 Offen Showmanship

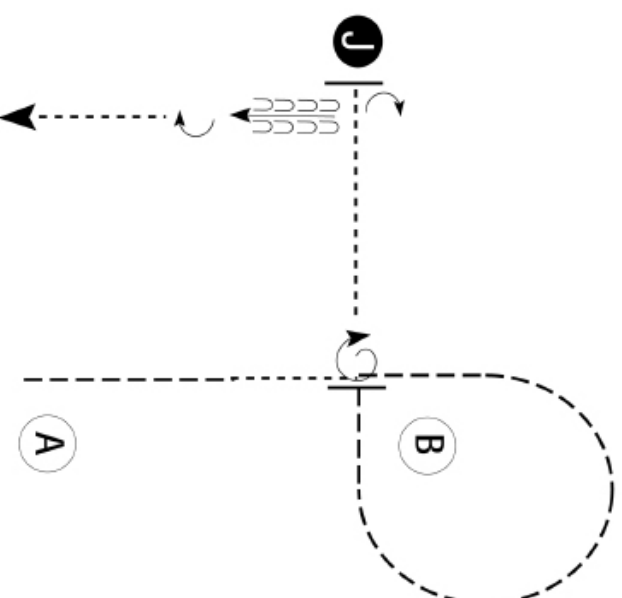

1. Trot halfway to B.
2. Walk two horse lengths.
3. Trot to and around B as shown.
4. Trot past B and stop. Perform a 360 degree turn.
5. Walk to judge and set up for inspection.
6. When dismissed, perform a 90 degree turn and back approximately 2 horse lengths.
7. Perform a 180 degree turn and walk straight away.

NOTE: The drawn description of this pattern is only intended for the general depictions of the pattern. Contestants should utilize the arena space to best exhibit their horses.

AQHA 4120 Youth Showmanship
AQHA 3120 Novice Amateur Showmanship

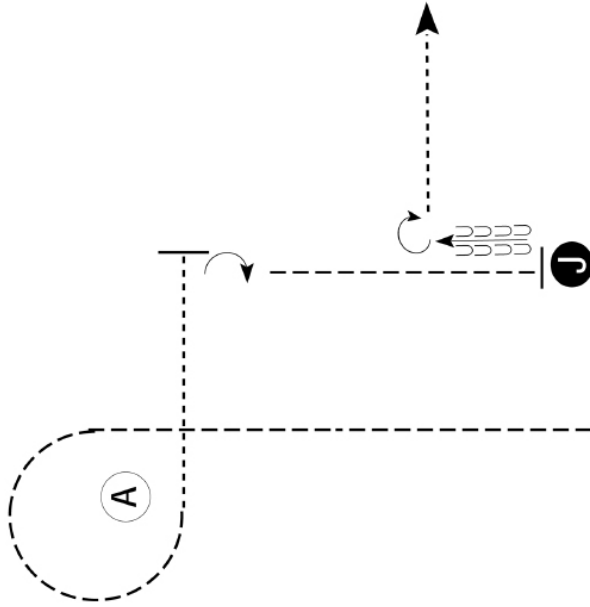

Be ready even with judge.

1. Trot to and around A.
2. Walk from A until even with judge.
3. Stop and perform a 90 degree turn.
4. Trot to the judge.
5. Stop and set up for inspection.
6. When dismissed, Back approximately 2 horse lengths.
7. Perform a 270 degree turn.
8. Walk straight away from judge.

NOTE: The drawn description of this pattern is only intended for the general depictions of the pattern.
Contestants should utilize the arena space to best exhibit their horses.

6810 Showmanship VWB-Jungpferde-Cup
AQHA 2120 Amateur Showmanship

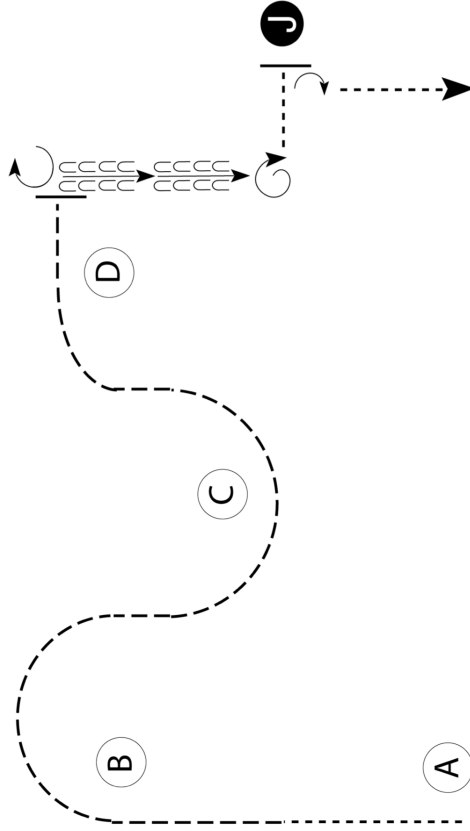

Be ready at A.

1. Walk from A halfway to B.
2. Trot around markers B, C and past D.
3. Stop. Perform a 270 degree turn.
4. Back.
5. Perform 1 1/4 turns and walk to the judge.
6. Stop and set up for inspection.
7. When dismissed, perform a 1/4 turn and walk away.

NOTE: The drawn description of this pattern is only intended for the general depictions of the pattern.
Contestants should utilize the arena space to best exhibit their horses.

VWB 8407 Novice Jugend Horsemanship

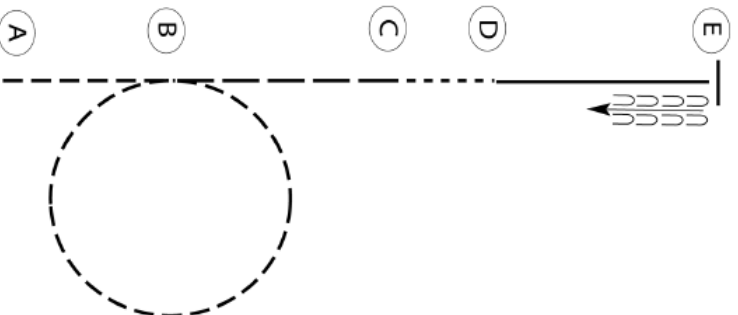

- Be ready at A.
1. Jog from A to B.
 2. Jog a circle to the right at B.
 3. Extend the jog to C.
 4. Walk from C to D.
 5. Lope on the right lead to E.
 6. Stop at E and back one horse length.

NOTE: The drawn description of this pattern is only intended for the general depictions of the pattern. Contestants should utilize the arena space to best exhibit their horses.

8408 VWB Jugend Horsemanship 9120 VWB Einsteiger Horsemanship

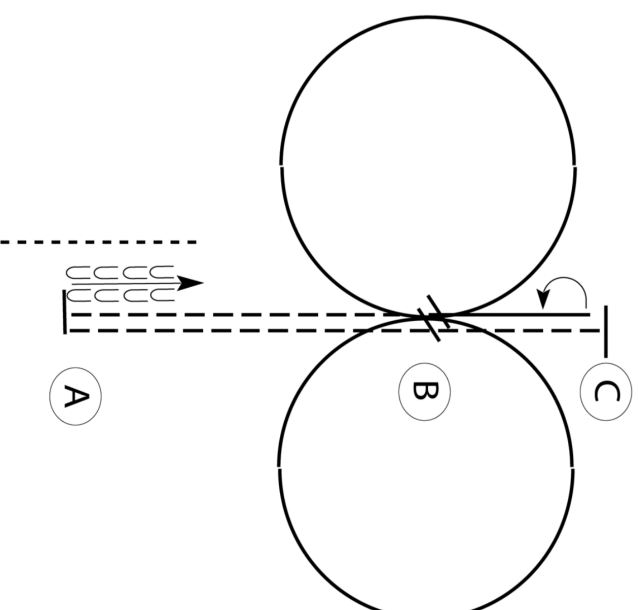

- Be ready at A.
1. Jog from A to C.
 2. Stop at C and perform a 180 degree turn to the left.
 3. Lope on the left lead to B.
 4. Lope a circle to the left.
 5. Perform a simple lead change at B.
 6. Lope a circle to the right.
 7. Jog from B to A.
 8. Stop at A and back approximately one horse length.
 9. Walk to A and exit at a walk.

NOTE: The drawn description of this pattern is only intended for the general depictions of the pattern. Contestants should utilize the arena space to best exhibit their horses.

VWB 7400 Amateur Horsemanship
 VWB 7408 Amateur Horsemanship Select

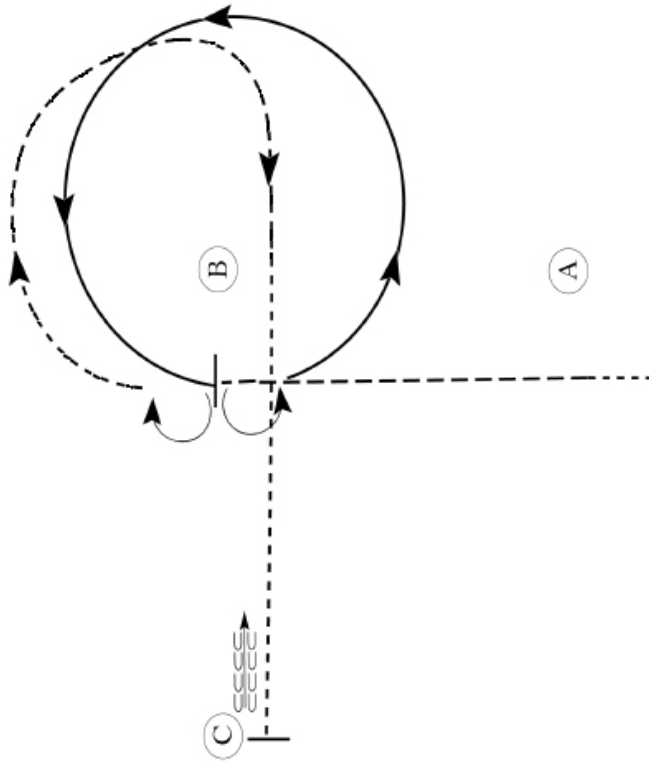

- Be ready before A.
1. Walk to a.
 2. Jog to B. Stop and turn 180 degrees left.
 3. Lope a circle to the left on the left lead.
 4. Stop at B. Turn 180 degrees to the right.
 5. Perform an extended jog circle to the right.
 6. Slow to the jog at B.
 7. Jog to C.
 8. Stop at C and back approximately one horse length.

NOTE: The drawn description of this pattern is only intended for the general depictions of the pattern. Contestants should utilize the arena space to best exhibit their horses.

AQHA 4400 Youth Horsemanship
 AQHA 3400 Novice Amateur Horsemanship

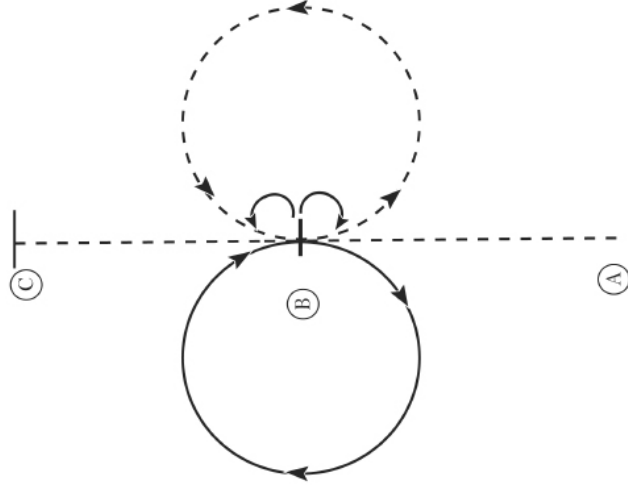

1. Jog A to B.
2. Stop at B and perform a 180 degree turn to the right on the hindquarters.
3. Jog a circle to the left.
4. At B lope a circle to the right on the right lead.
5. Stop at B and perform a 180 degree turn to the left.
6. Jog B to C.
7. Stop at C.

NOTE: The drawn description of this pattern is only intended for the general depictions of the pattern. Contestants should utilize the arena space to best exhibit their horses.

VWB-Show in Kreuth 2024

19.-22. September 2024
Indian Summer Show

- VWB Kat I-Show, NRHA (USA) -Show -



AQHA 2400 Amateur Horsemanship
 AQHA 2408 Amateur Select Horsemanship

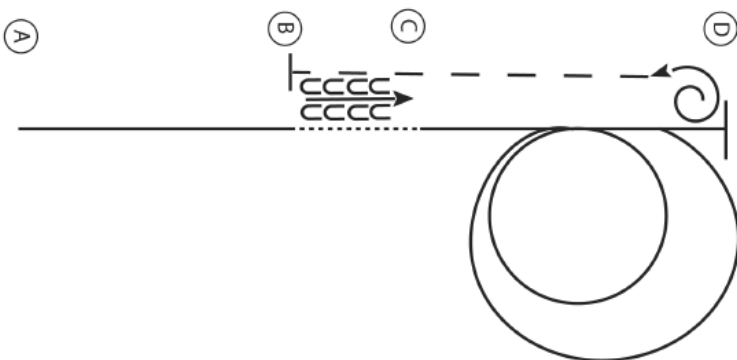

1. Lope A to B on the left lead.
2. Walk B to C.
3. At C lope on the right lead towards D.
4. Before D lope a large fast circle to the right followed by a small slow circle to the right and continue to D.
5. At D stop and perform a 540 degree turn to the left.
6. Extend the jog to B.
7. At B stop and back to C.

NOTE: The drawn description of this pattern is only intended for the general depictions of the pattern. Contestants should utilize the arena space to best exhibit their horses.

