

Indian Summer Show

Kreuth 2024

Patternbook



Patternbook

Reining

8347	VWB	Novice Jugend Reining	VWB-Pattern	5
8348	VWB	Jugend Reining	VWB-Pattern	6
9340	VWB	Einsteiger Reining	VWB-Pattern	8
7340	VWB	Amateur Reining	VWB-Pattern	4
6340	VWB	Offen Reining	VWB-Pattern	15
5340	VWB	Jackpot Reining Amateur/Youth	VWB-Pattern	12
N1100	NRHA	Open Trophy	NRHA-Pattern	10
N2930	NRHA	Snaffle Bit / Hackamore 5 & Under	NRHA-Pattern	6
N1400	NRHA	Non Pro Trophy	NRHA-Pattern	14
N1500	NRHA	Intermediate Non Pro	NRHA-Pattern	11
N3200	NRHA	Youth 14-18	NRHA-Pattern	5
N3100	NRHA	Youth 13 & Under	NRHA-Pattern	6

Ranch Riding

6430	VWB	Offen Ranch Riding	VWB-Pattern	7
7430	VWB	Amateur Ranch Riding	VWB-Pattern	8
8430	VWB	Jugend Ranch Riding	VWB-Pattern	15
9430	VWB	Einsteiger Ranch Riding	VWB-Pattern	3
5430	VWB	Jackpot Ranch Riding Amateur/Y.	VWB-Pattern	13
9960	VWB	Walk/Trot Ranch Riding	Seite	22

Jungpferde

6840	VWB	Jungpferde Reining	VWB-Pattern	1
6880	VWB	Jungpferde Trail	VWB-Pattern	1
6890	VWB	Jungpferde Basis	VWB-Pattern	1

Trail

5380	VWB	Amateur/Youth Jackpot Trail	Seite	9
6380	VWB	Offen Trail	Seite	3
6390	VWB	Ranch Trail	Seite	5
6810	VWB	Trail in Hand	Seite	10
7380	VWB	Amateur Trail	Seite	8
8387	VWB	Novice Jugend	Seite	7
8388	VWB	Jugend	Seite	6
9380	VWB	Einsteiger Trail	Seite	4
9980	VWB	Walk/Trot Trail	Seite	11
9991	VWB	Lead Line Trail	Seite	12

Showmanship

VWB	alle Showmanships	Seite	13-16
-----	-------------------	-------	-------

Horsemanship

VWB	alle Horsemanships	Seite	17-21
-----	--------------------	-------	-------

FRIDAY 20.9.2024
#6380 VWB TRAIL ALL AGES

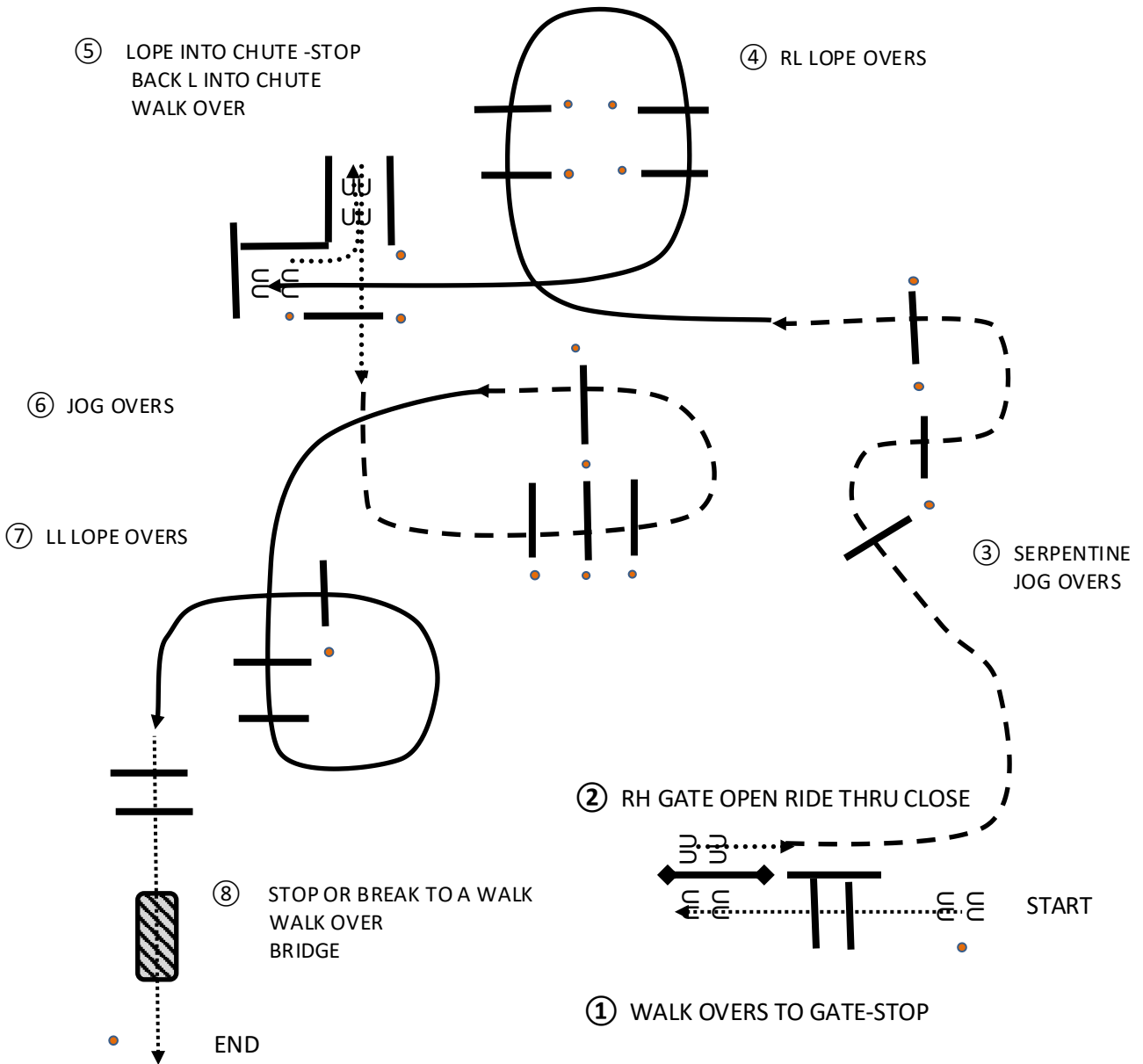

ANNDENNISDESIGN COPYRIGHT 2024
ALL RIGHTS RESERVED

FRIDAY 20.9.2024
#9380 VWB EINSTEIGER TRAIL

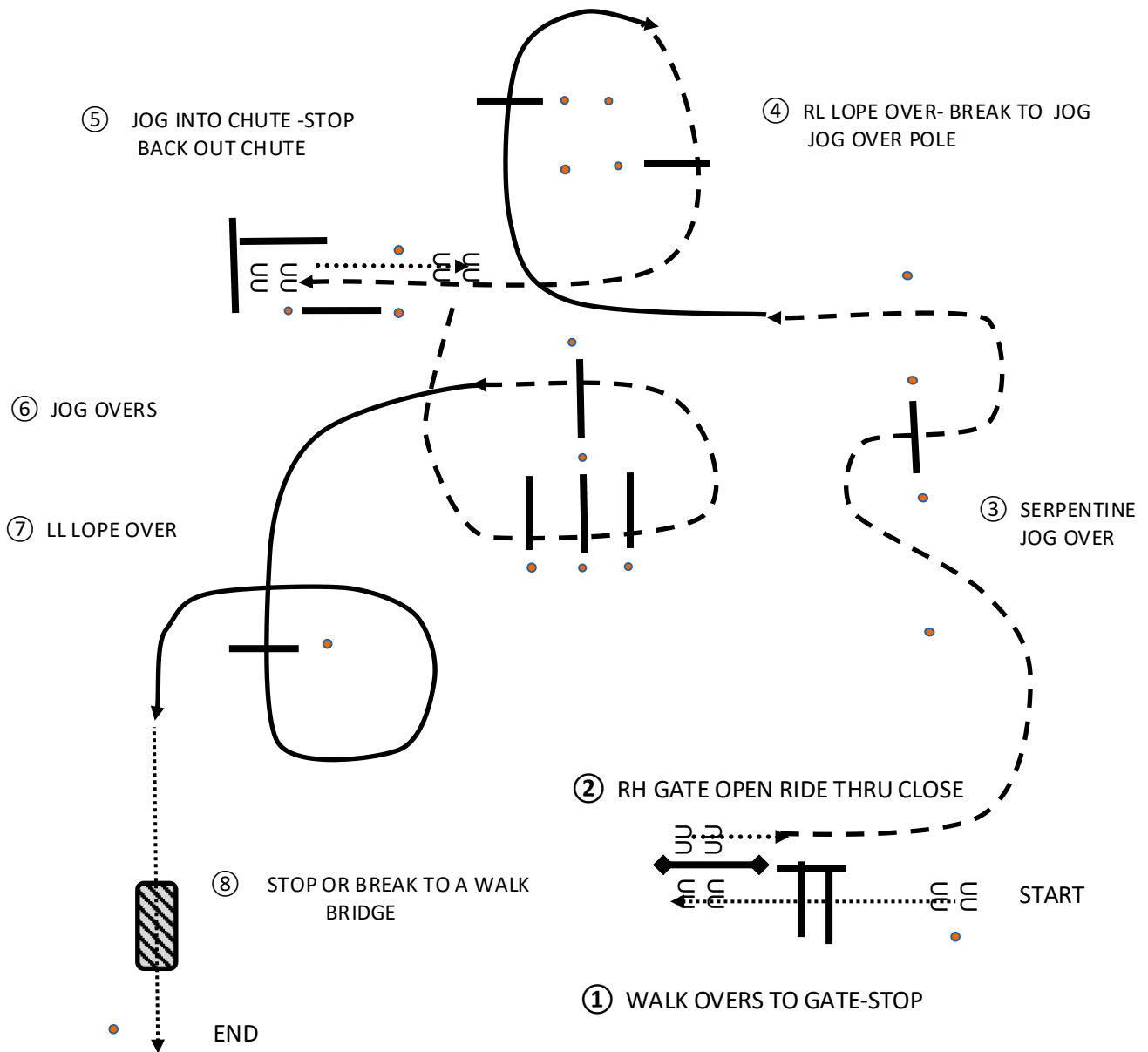

ANN DENNIS DESIGN COPYRIGHT 2024
ALL RIGHTS RESERVED

FRIDAY 20.9.2024
#6390 VWB OPEN RANCH TRAIL

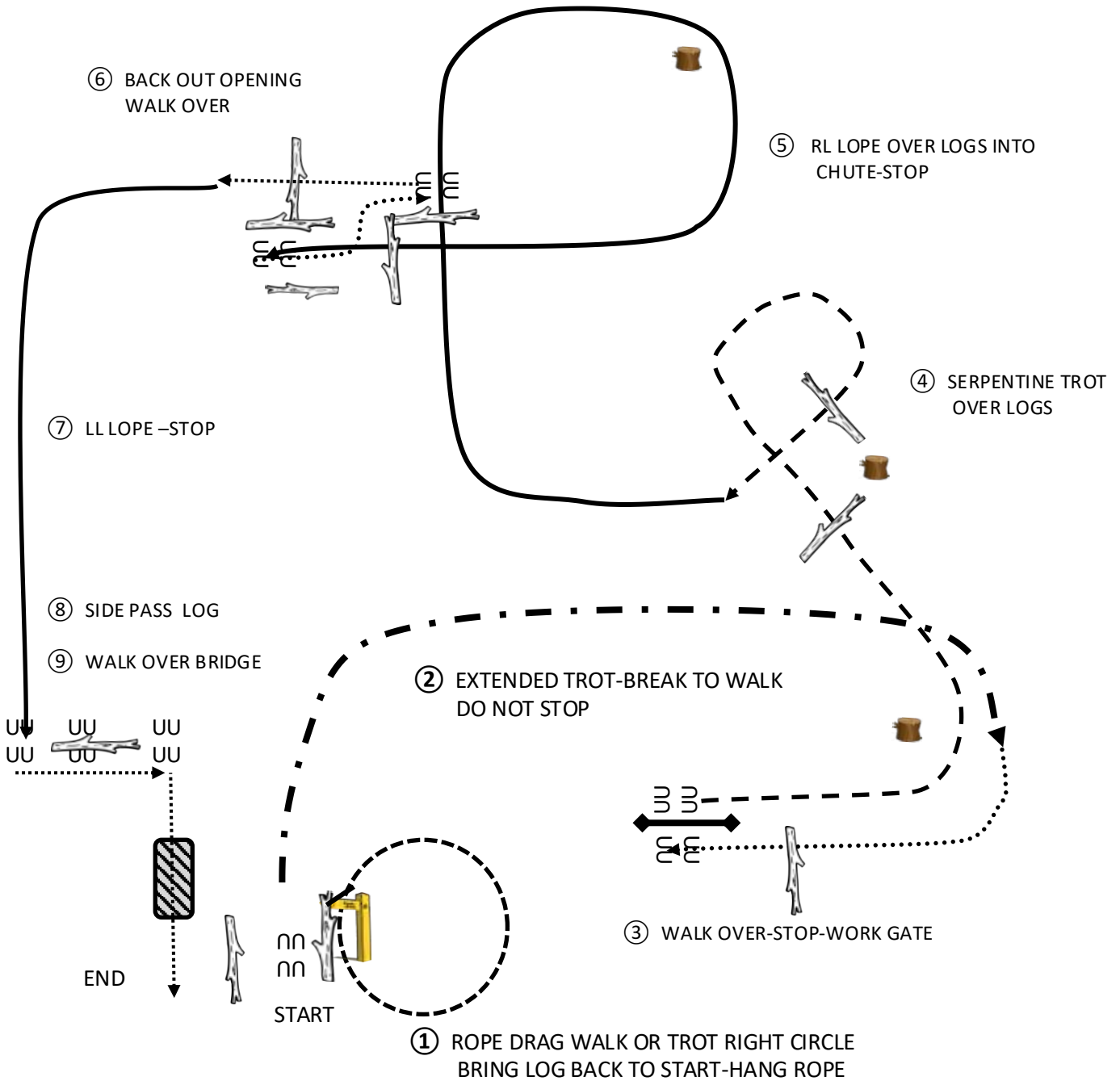

ANN DENNIS DESIGN COPYRIGHT 2024
ALL RIGHTS RESERVED

SATURDAY 21.9.2024
#8388 VWB YOUTH TRAIL

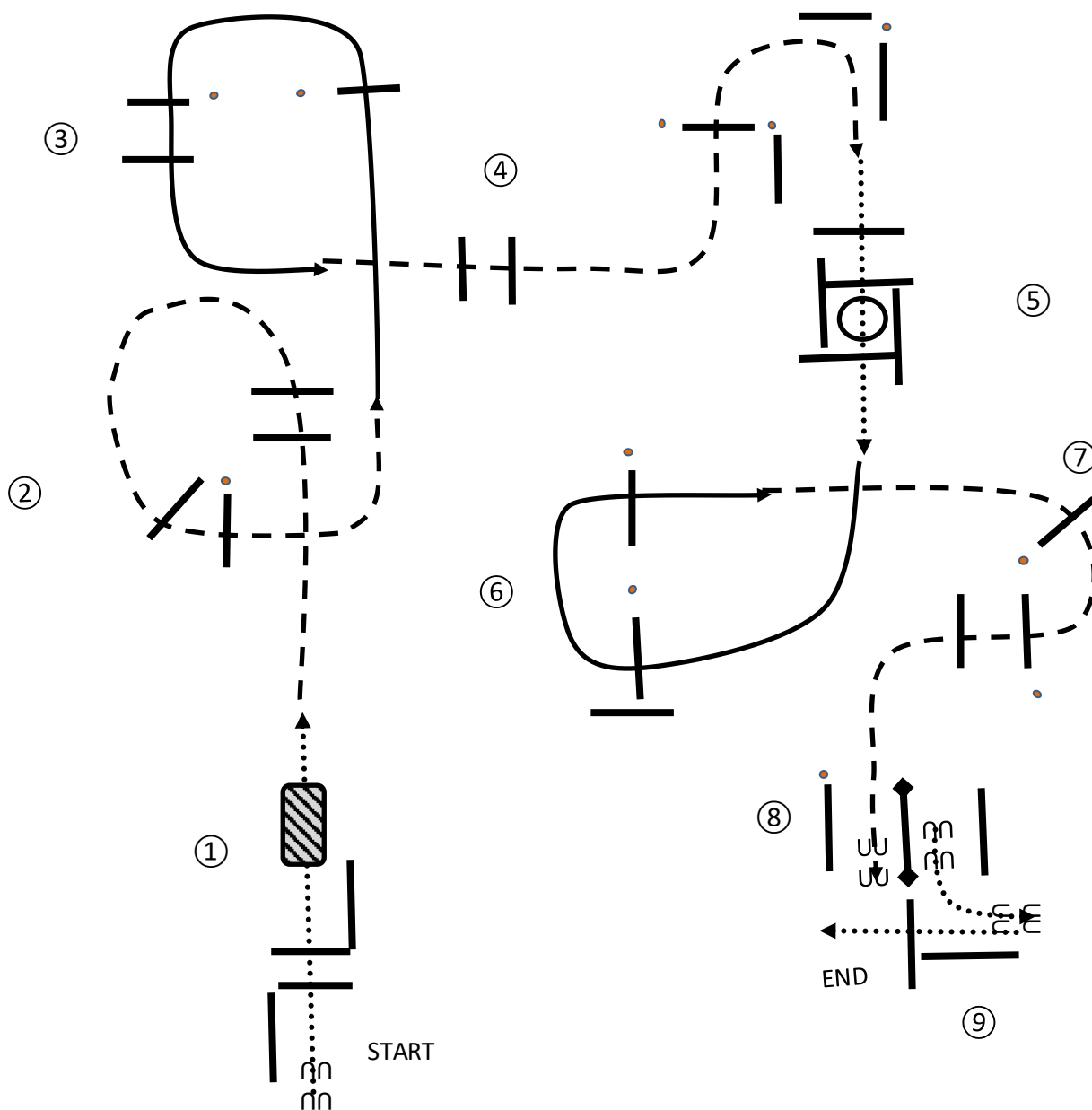

- 1 WALK OVERS - BRIDGE
- 2 JOG OVERS
- 3 LL LOPE OVER POLES
- 4 BREAK TO A JOG-JOG OVER POLES
- 5 BREAK TO THE WALK OR STOP-WALK OVER POLES- 360 RIGHT OR LEFT-WALK OVER POLE
- 6 RL LOPE OVER POLES
- 7 SERPENTINE JOG OVERS TO GATE
- 8 STOP-LH GATE OPEN RIDE THROUGH CLOSE
- 9 BACK L-WALK OVERS POLE TO END PATTERN

ANNDENNISDESIGN COPYRIGHT 2024
ALL RIGHTS RESERVED

SATURDAY 21.9.2024
 #8387 VWB NOVICE JUGEND TRAIL

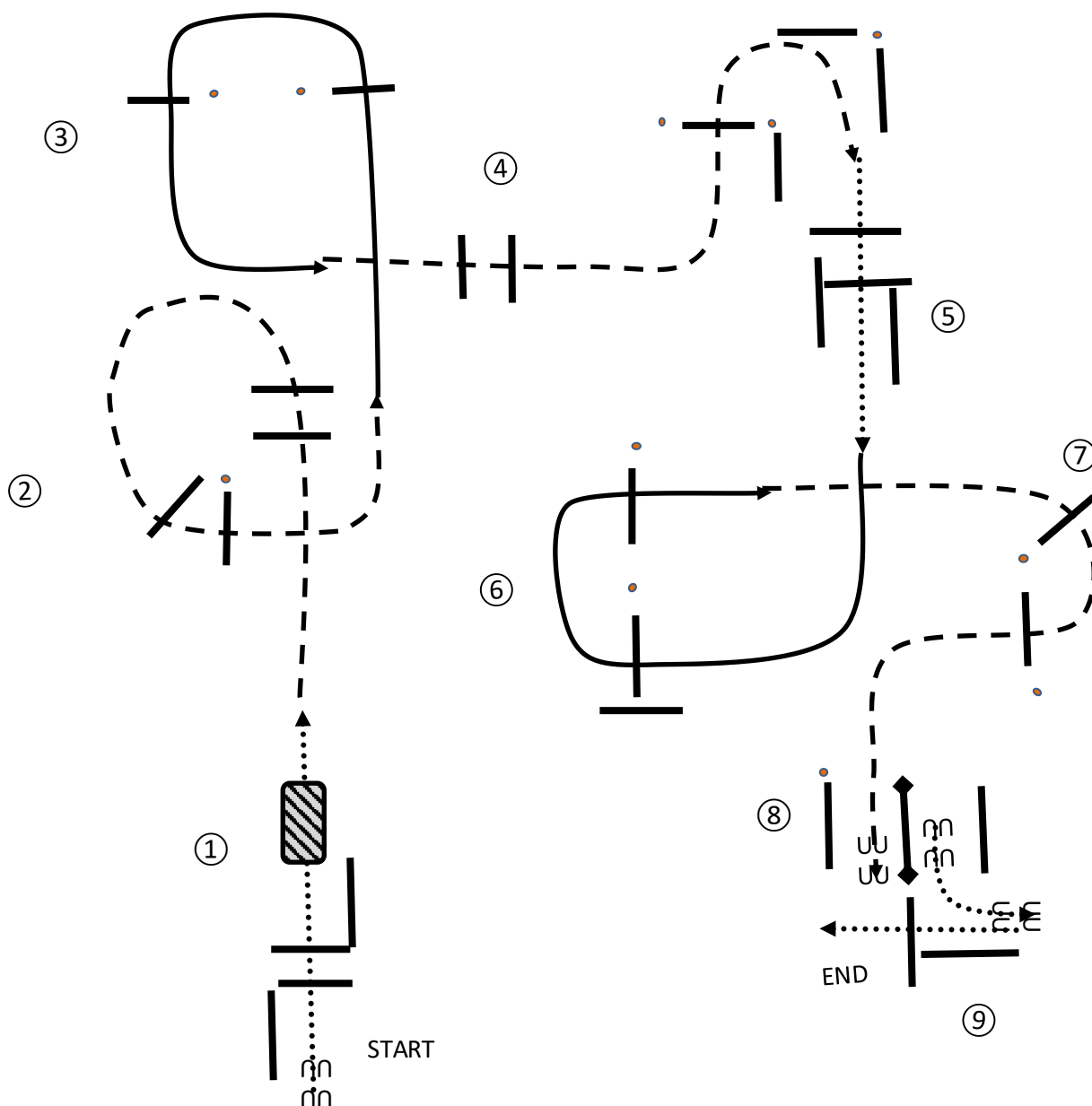

- 1 WALK OVERS - BRIDGE
- 2 JOG OVERS
- 3 LL LOPE OVER POLES
- 4 BREAK TO A JOG-JOG OVER POLES
- 5 BREAK TO THE WALK OR STOP-WALK OVER POLES
- 6 RL LOPE OVER POLES
- 7 SERPENTINE JOG OVERS TO GATE
- 8 STOP-LH GATE OPEN RIDE THROUGH CLOSE
- 9 BACK L-WALK OVER POLE TO END PATTERN

ANNDENNISDESIGN COPYRIGHT 2024
 ALL RIGHTS RESERVED

SATURDAY 21.9.2024
#7380 VWB AMATEUR TRAIL

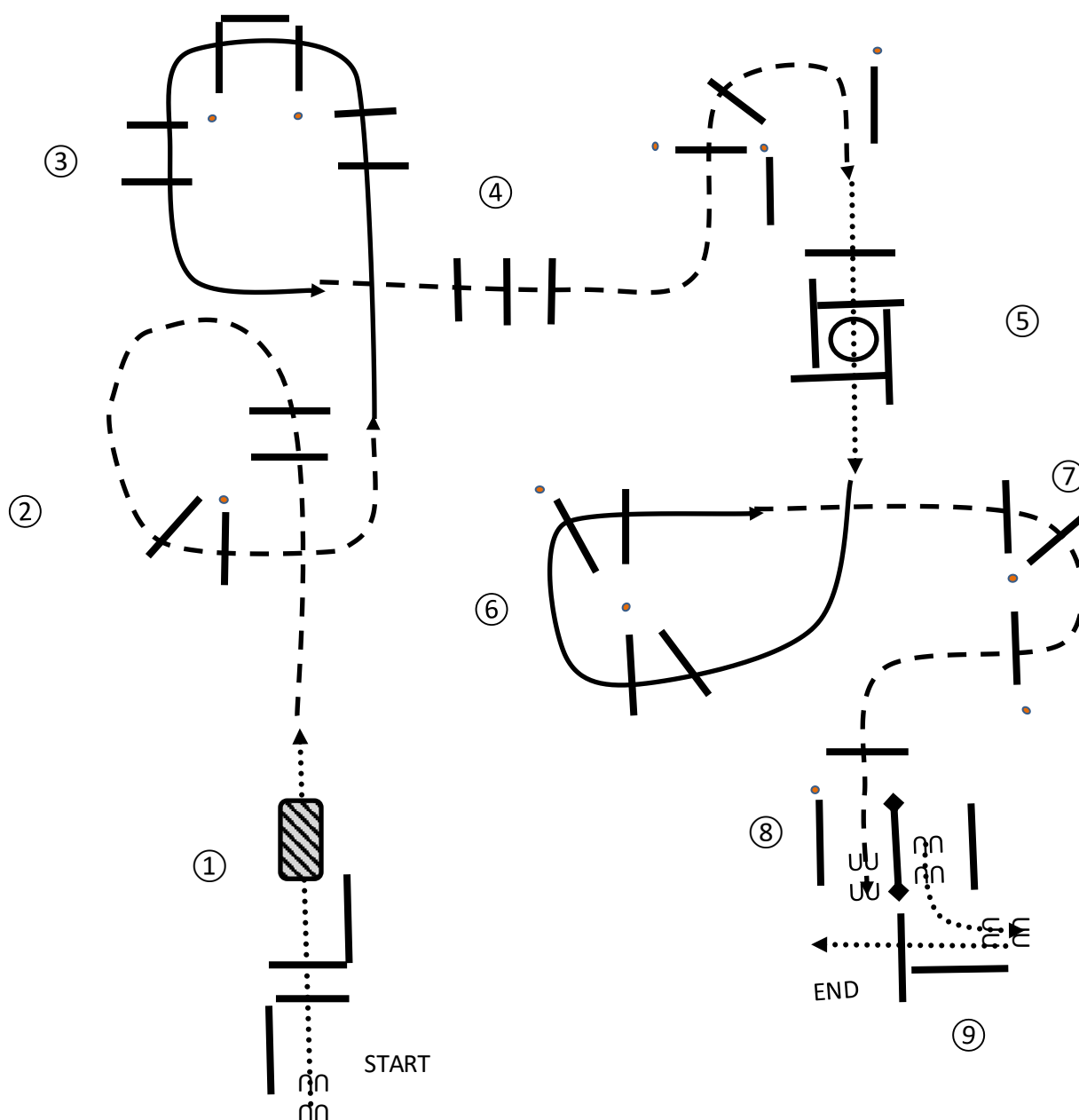

- 1 WALK OVERS - BRIDGE
- 2 JOG OVERS
- 3 LL LOPE OVER POLES
- 4 BREAK TO A JOG-JOG OVER POLES
- 5 BREAK TO THE WALK OR STOP-WALK OVER POLES- 360 RIGHT OR LEFT-WALK OVER POLE
- 6 RL LOPE OVER POLES
- 7 SERPENTINE JOG OVERS TO GATE
- 8 STOP-LH GATE OPEN RIDE THROUGH CLOSE
- 9 BACK L-WALK OVER POLE TO END PATTERN

ANN DENNIS DESIGN COPYRIGHT 2024
ALL RIGHTS RESERVED

SATURDAY 21.9.2024
#5380 VWB AMATER/YOUTH JACK-POT TRAIL

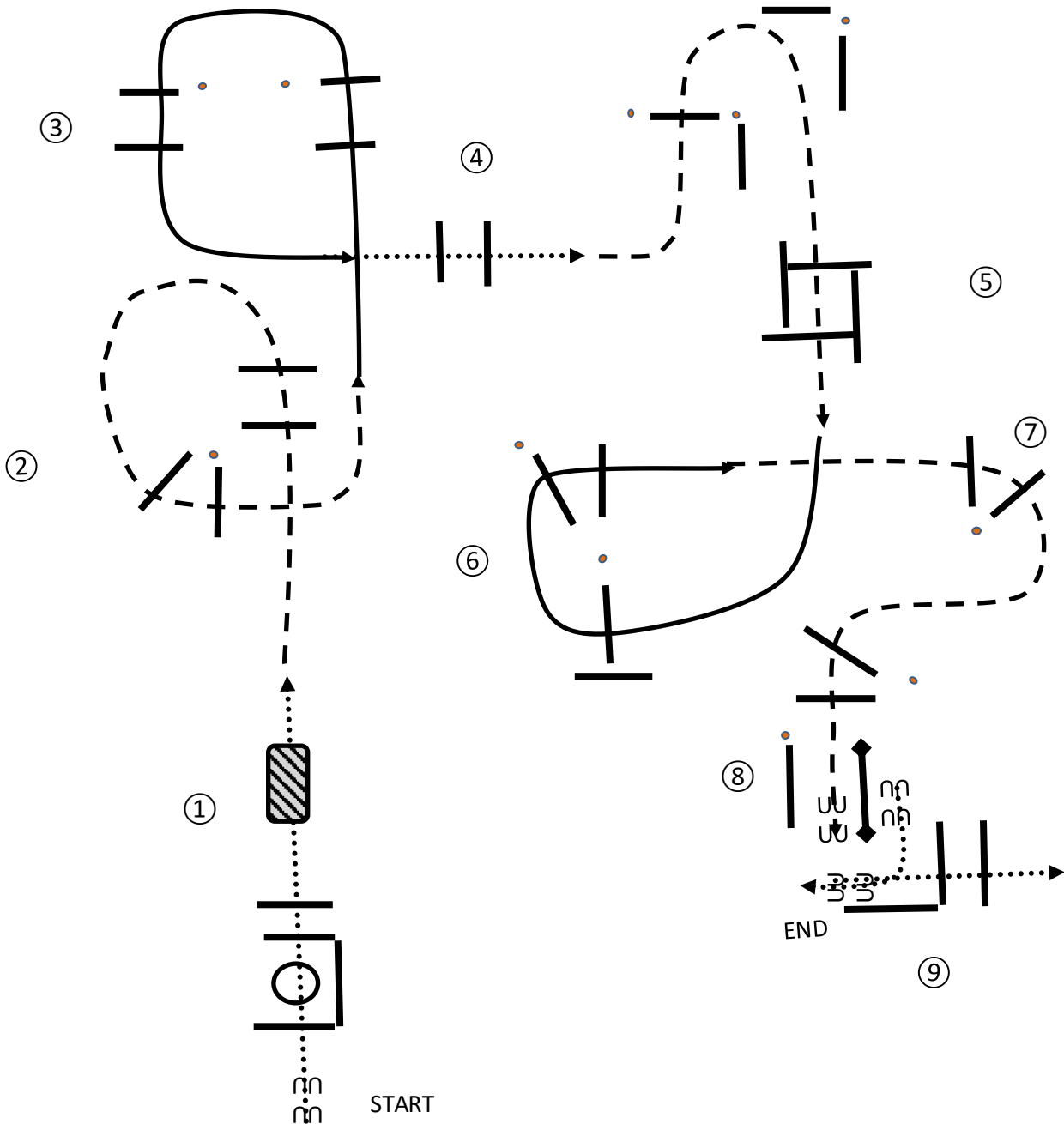

- | | |
|---|--|
| <ul style="list-style-type: none"> 1 WALK OVER - 360 RIGHT OR LEFT - WALK OVERS - BRIDGE 2 JOG OVERS 3 LL LOPE OVER POLES 4 BREAK TO THE WALK OR STOP - WALK OVERS 5 JOG OVERS THROUGH BOX | <ul style="list-style-type: none"> 6 RL LOPE OVERS 7 SERPENTINE JOG OVERS TO GATE 8 STOP-LH GATE OPEN RIDE THROUGH CLOSE 9 BACK L-WALK OVER POLES TO END PATTERN |
|---|--|

ANNDENNISDESIGN COPYRIGHT 2024
 ALL RIGHTS RESERVED

SATURDAY 21.9.2024
#6810 VWB TRAIL IN HAND

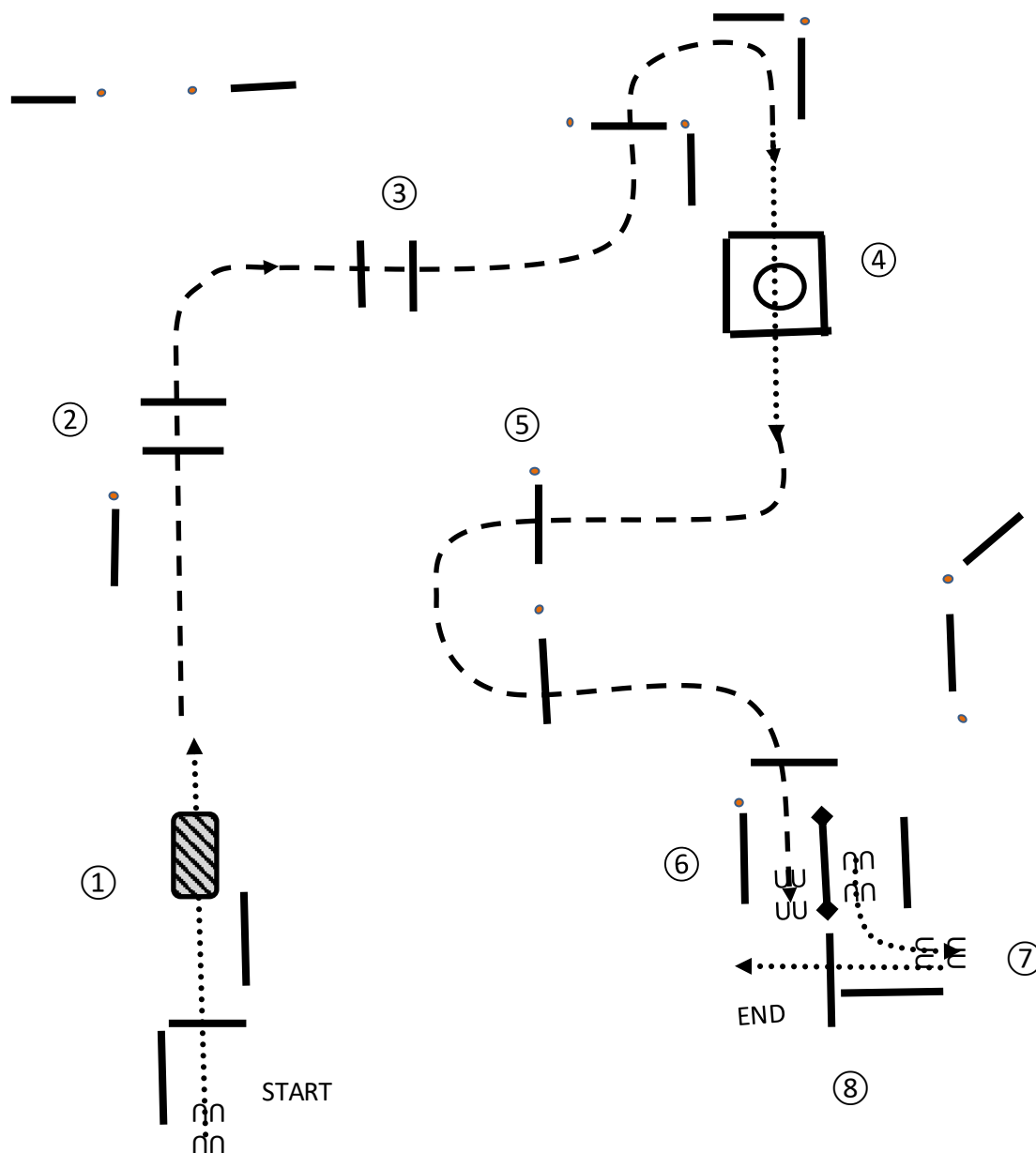

- 1 WALK OVER POLE - BRIDGE
- 2 TROT OVERS
- 3 TROT OVERS
- 4 BREAK TO THE WALK OR STOP-WALK IN BOX- 360 RIGHT-WALK OVER POLE
- 5 SERPENTINE TROT OVERS TO GATE
- 6 STOP-LH GATE OPEN RIDE THROUGH CLOSE
- 7 BACK L INTO CHUTE
- 8 WALK OVER POLE TO END PATTERN

ANNDENNISDESIGN COPYRIGHT 2024
 ALL RIGHTS RESERVED

SATURDAY 21.9.2024
 #9980 VWB WALK TROT OPEN TRAIL

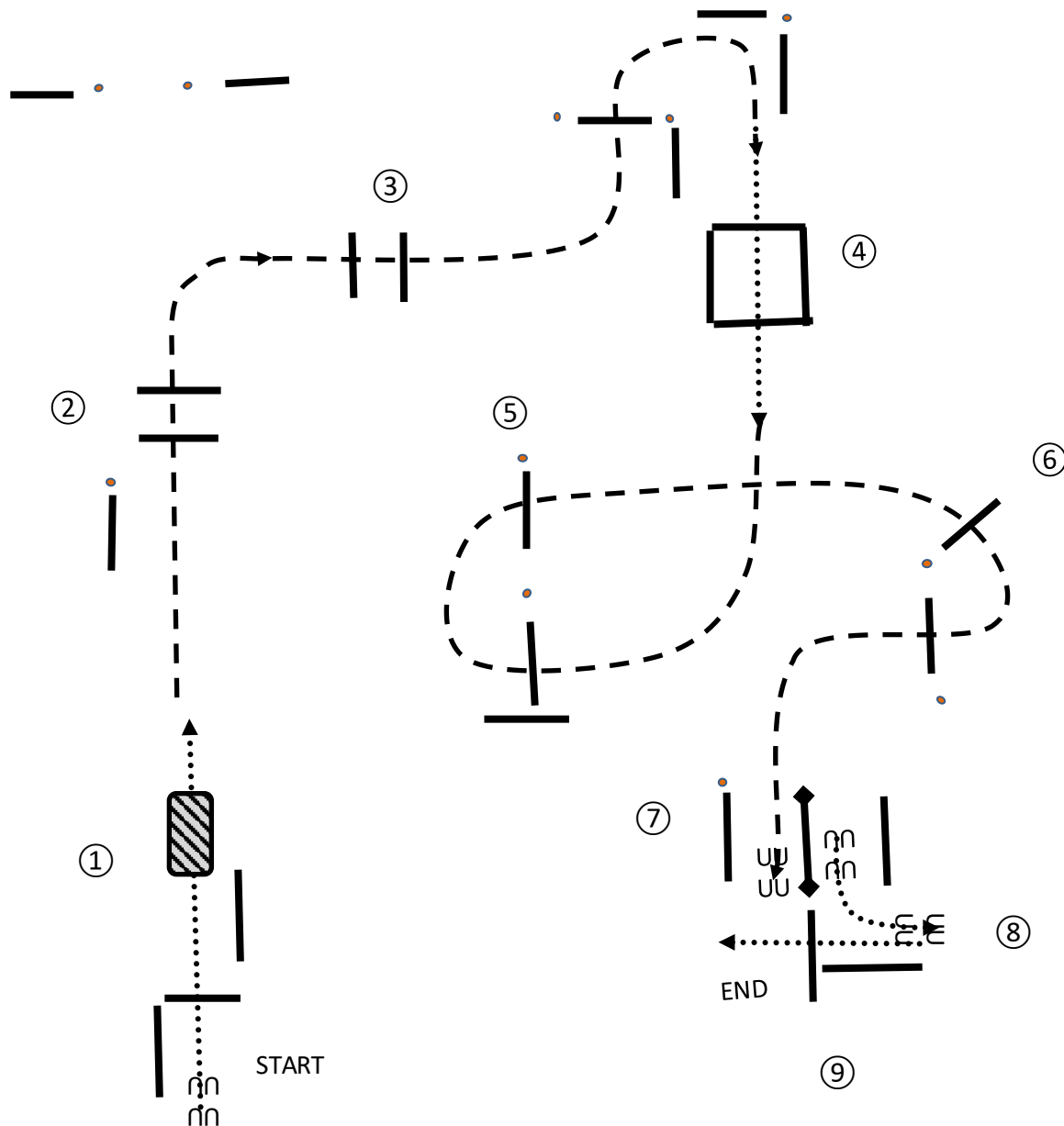

- 1 WALK OVER POLE - BRIDGE
- 2 TROT OVERS
- 3 TROT OVERS
- 4 BREAK TO THE WALK OR STOP-WALK OVERS
- 5 TROT OVERS
- 6 SERPENTINE TROT OVERS TO GATE-STOP
- 7 STOP-LH GATE OPEN RIDE THROUGH CLOSE
- 8 BACK L INTO CHUTE
- 9 WALK OVER POLE TO END PATTERN

ANN DENNIS DESIGN COPYRIGHT 2024
 ALL RIGHTS RESERVED

SATURDAY 21.9.2024
#5002 VWB LEAD LINE TRAIL

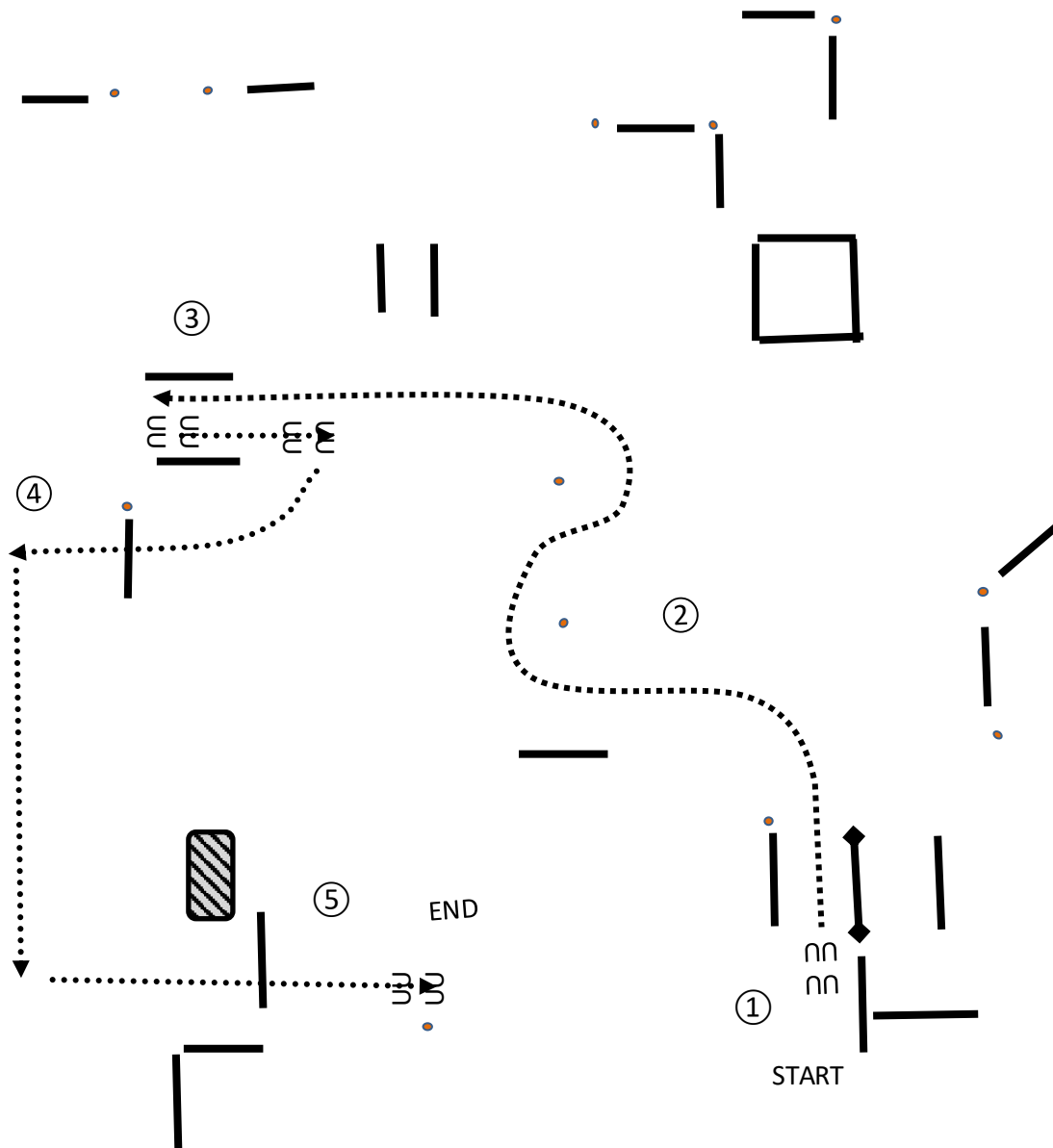

- 1 WALK PAST GATE
- 2 WALK SERPENTINE AROUND CONES
- 3 WALK INTO CHUTE - STOP - BACK OUT
- 4 WALK OVER
- 5 WALK OVER-STOP AT CONE-END OF PATTERN

ANN DENNIS DESIGN COPYRIGHT 2024
 ALL RIGHTS RESERVED

8127 VWB Novice Jugend Showmanship

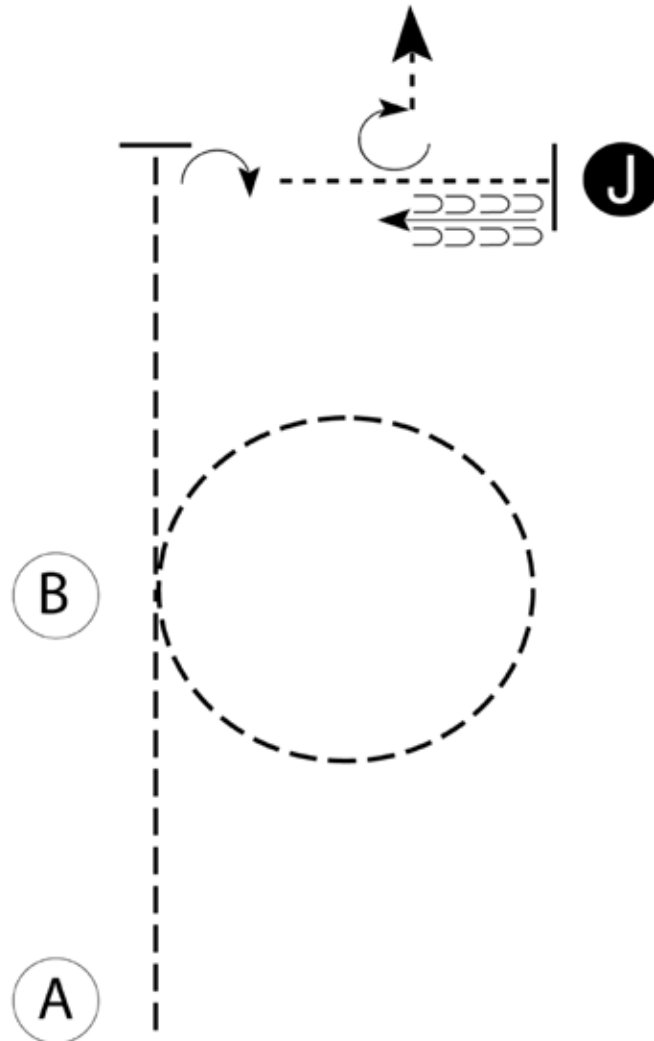

1. Trot to B.
2. Circle to the right at the trot as shown.
3. Extended trot until even with judge.
4. Perform a 1/4 turn.
5. Walk to judge and set up.
6. When dismissed, back approximately one horse length.
7. Perform a 3/4 turn.
8. Walk straight away and proceed to line up b following the instruction of your ring steward.

ISPECTION WILL BE DONE IN LINE UP.

8128 VWB Jugend Showmanship
9120 VWB Einsteiger Showmanship

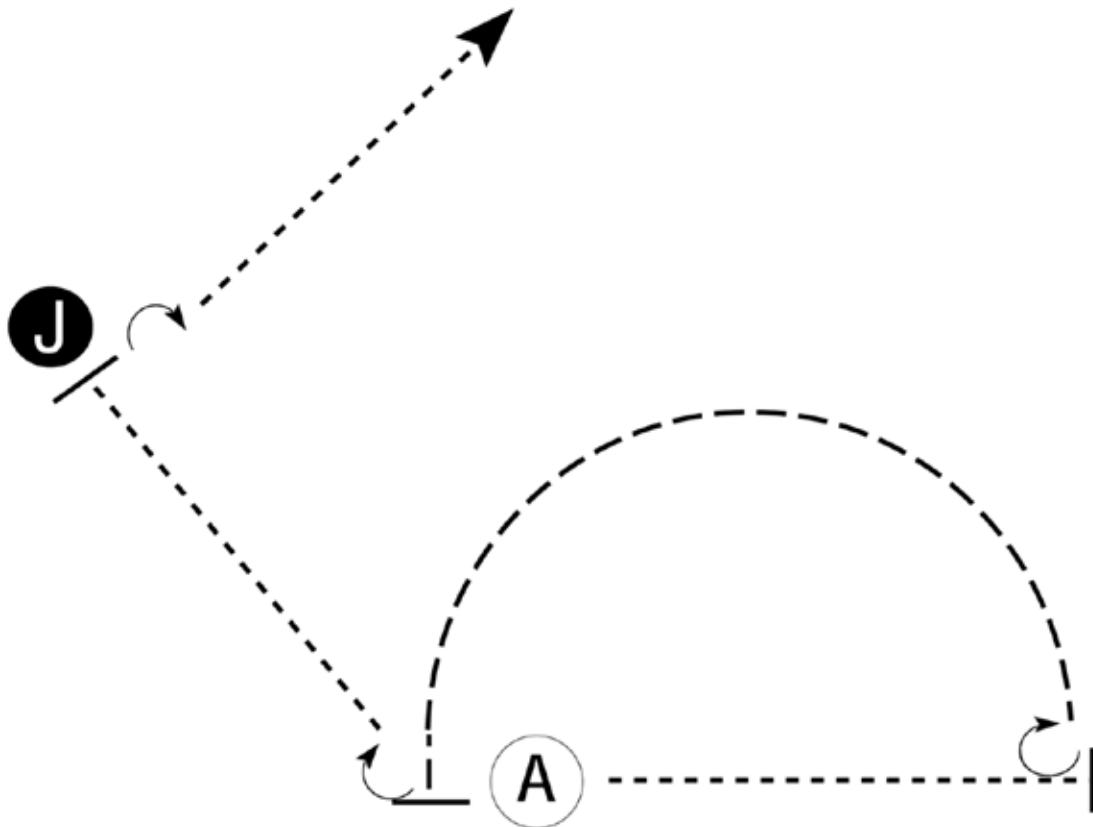

Be ready with your horse's tail to A.

1. When acknowledged, walk approximately 2 horse lengths.
2. Stop and perform a 270 degree turn.
3. Trot a half circle back to A.
4. Stop and perform a turn until you are straight in line with Judge.
5. Walk to judge. Stop and set up for inspection.
6. When dismissed, perform a 90 degree turn.
7. Walk straight away from judge.

7120 VWB Amateur Showmanship

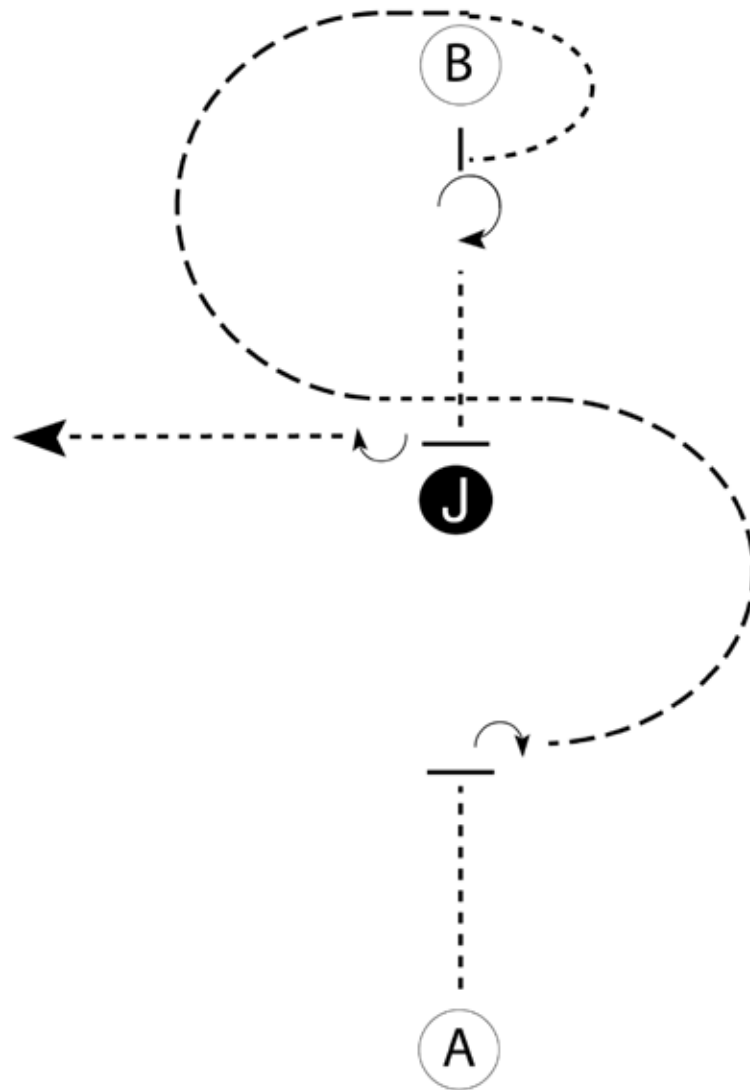

Be ready with your horse's tail to A.

1. Walk halfway to Judge.
2. Stop and perform a 1/4 turn.
3. Trot a half circle. Break to a walk before Judge and walk at least two horse lengths past Judge.
4. Trot a half circle to B then walk around B as shown.
5. Stop and perform a 3/4 turn and walk to Judge.
6. Stop and set up for inspection.
7. When dismissed, perform a 1/4 turn and walk straight away to exit.

6120 VWB Offen Showmanship

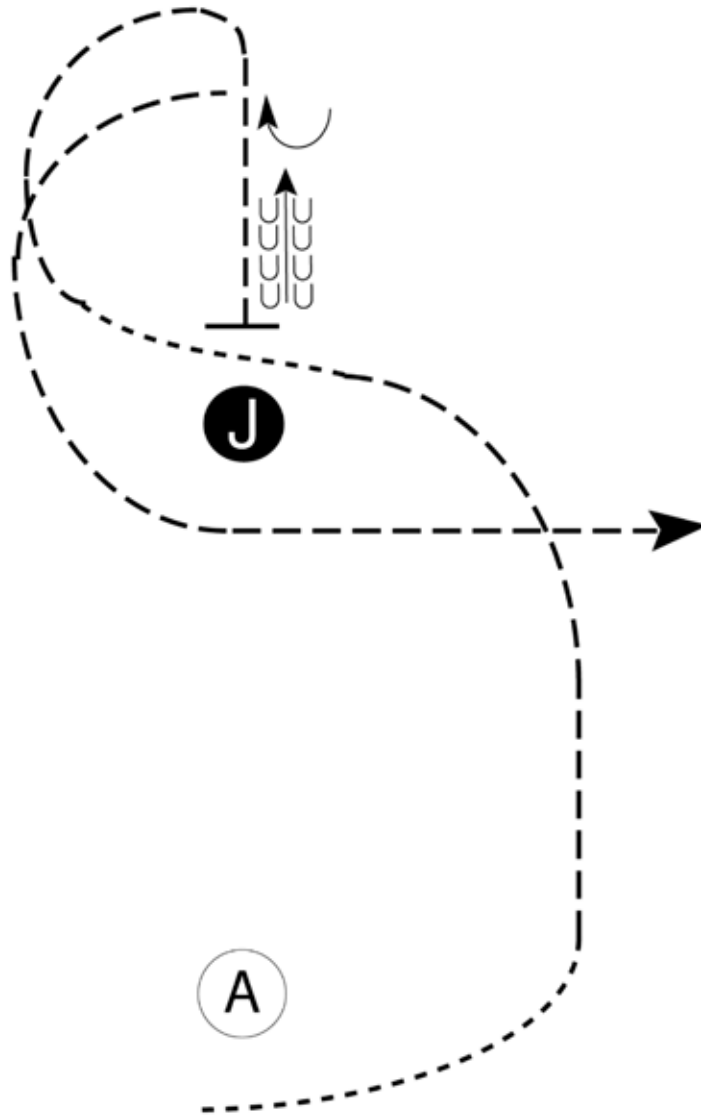

Be ready at A.

1. Walk approximately 2 horse lengths from A.
2. Trot in a half circle until just before Judge.
3. Break to walk and walk past Judge.
4. Trot in a half circle and straight to Judge as shown.
5. Stop and set up for inspection.
6. When dismissed, back approximately one horse length.
7. Perform a 1/4 turn.
8. Trot in a half circle and to exit.

8407 VWB Novice Jugend Horsemanship

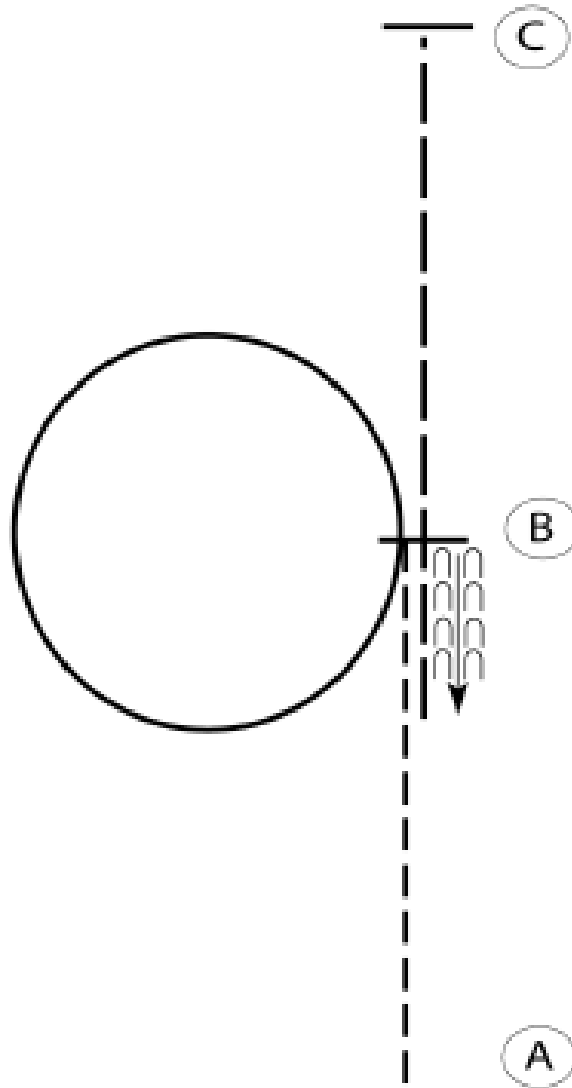

Be ready at A.

1. Jog from A to B.
2. Lope a circle to the left on the left lead.
3. Stop at B.
4. Back one horse length at B.
5. Extend the jog to C.
6. Stop at C.

8408 VWB Jugend Horsemanship

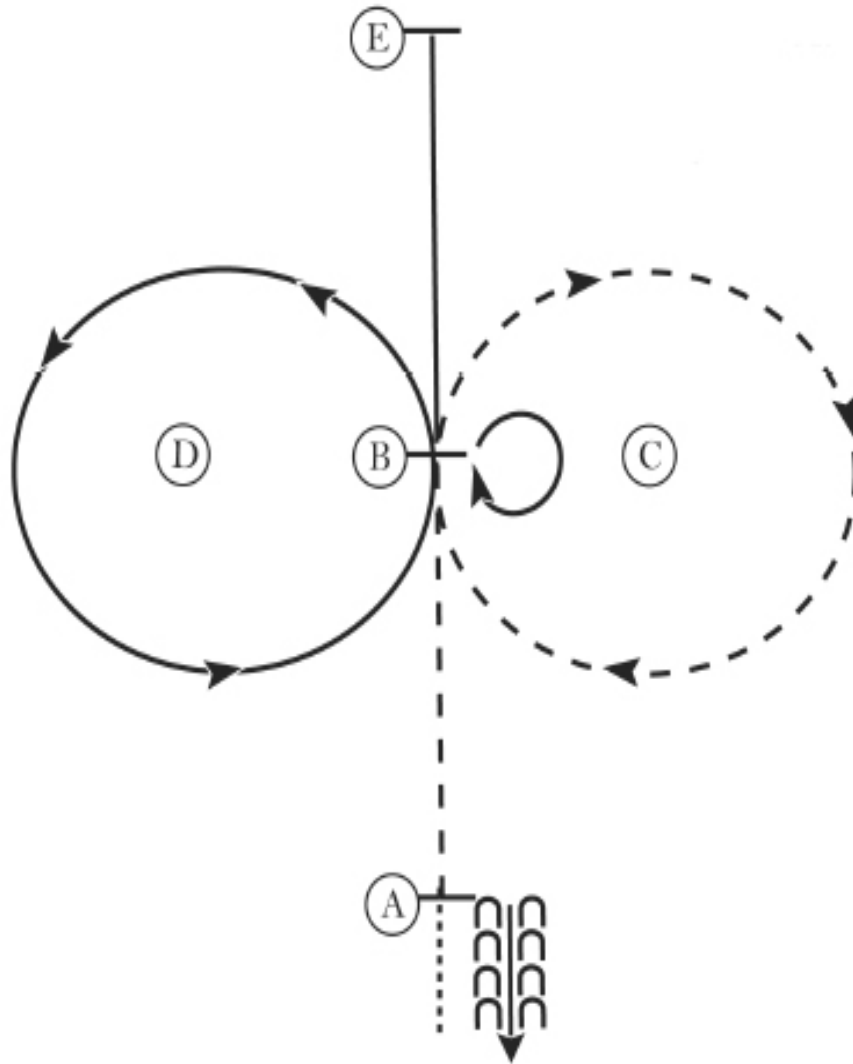

1. Walk to A.
2. At A stop and back 3 steps.
3. Jog A to B.
4. Stop at B and perform a 360 degree turn to the right.
5. Jog a circle to the right around C.
6. At B lope on the left lead, lope a circle to the left around D.
7. Continue the lope to E.
8. Stop at E.

9400 VWB Einsteiger Horsemanship

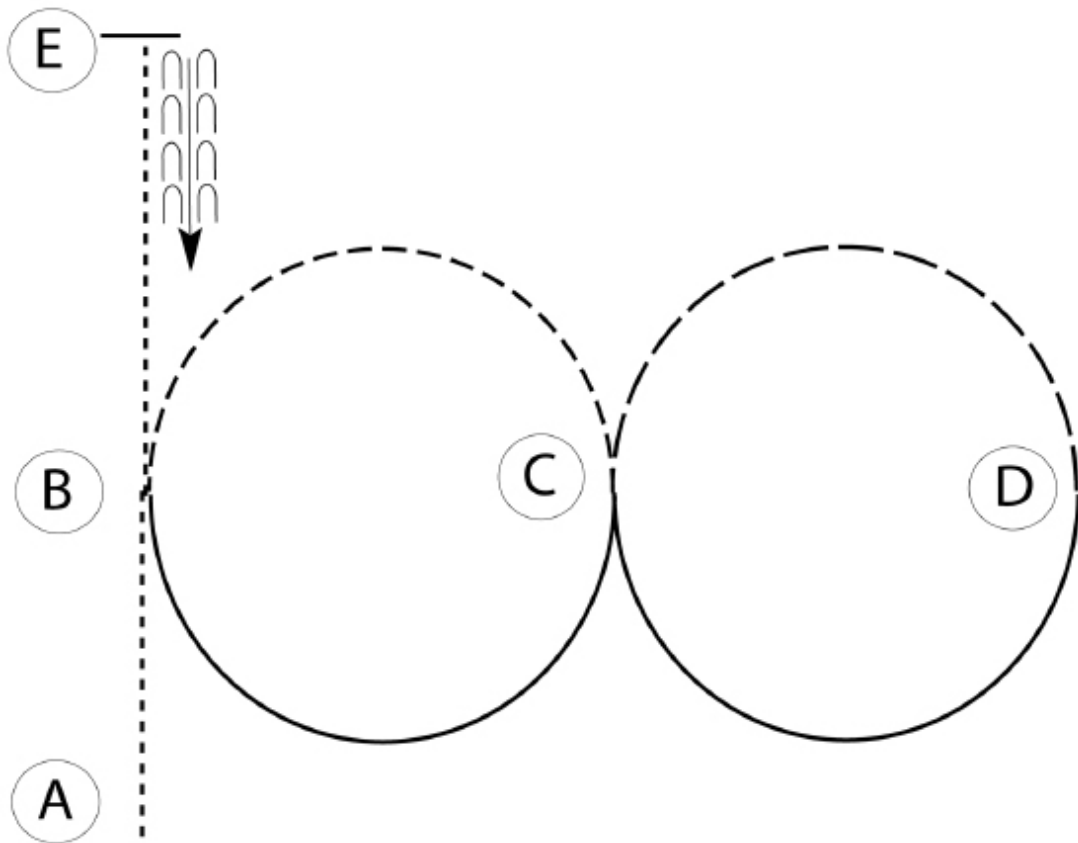

Be ready at A.

1. Walk A to B.
2. Jog a half circle to C.
3. Lope a half circle on the left lead to D.
4. Extend the jog in a half circle to C.
5. Lope a half circle on the right lead to B.
6. Walk to E.
7. Stop at E and back approximately one horse length.

7400 VWB Amateur Horsemanship

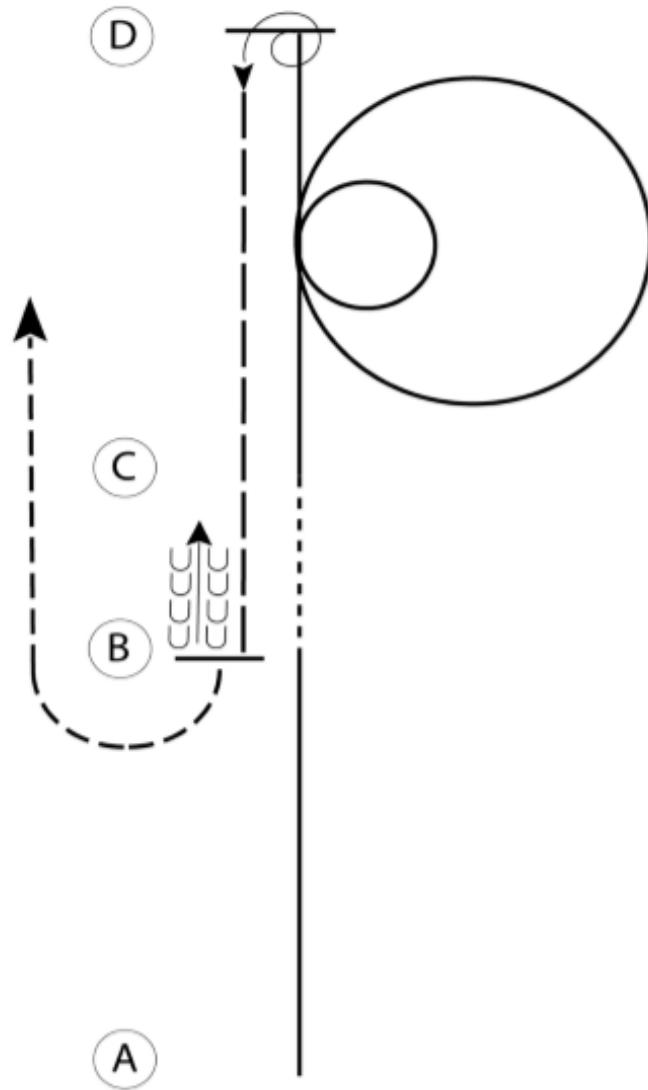

1. Lope left lead from A to B.
2. Walk from B to C.
3. Lope right lead at C.
4. Lope a large fast circle to the right.
5. Lope a small slow circle to the right.
6. At D stop and turn 1 1/2 times on the hindquarters to the left.
7. Extend the jog to B. At B stop and back to C.
8. Jog around B to the exit.

9940 Walk-Trot Horsemanship

1. jog serpentine between A and B
2. stop and turn 180°right
3. half circle ext. jog to C
4. half circle walk to the right
5. half circle jog back to C
6. at C, ext. trot half way to D
7. walk to D
8. stop and back min. 1 horse length

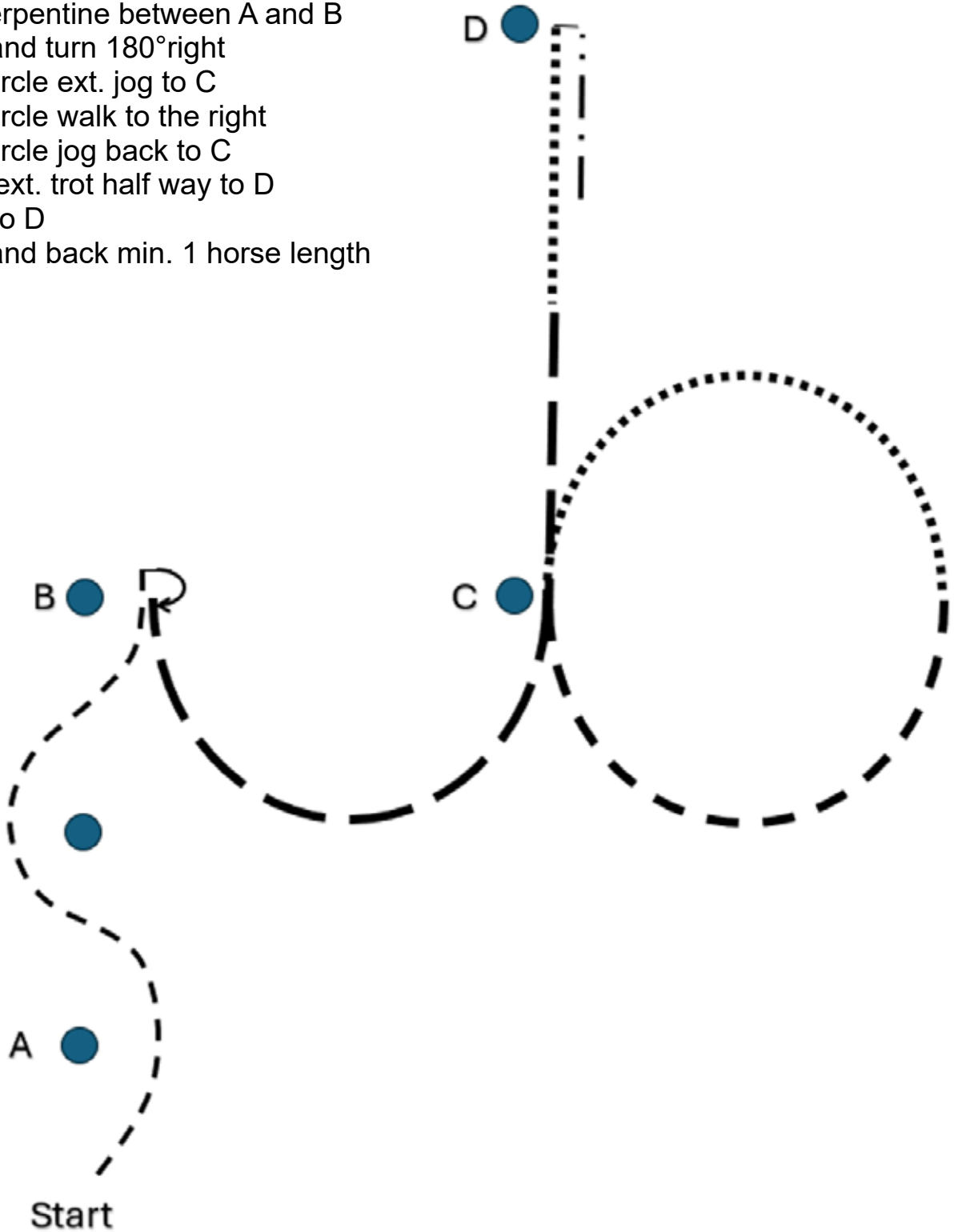

9960 Walk-Trot Ranch Riding

